

ALPHA[®] 



PRODUCTS LIST
2024

www.alualpha.pt



NEW

OB07GC10

Orizon Tilt and Turn
p. A21

NEW

9326

Orizon Line
p. B4Sliding Accessories
p. K1

NEW

CM37

Multipoint Locks
p. J7

NEW

N87

Counterplates
p. Q4

NEW

2046i

Exo Line
p. L1

NEW

2058i

Exo Line
p. L3

NEW

2097i

Exo Line
p. L8







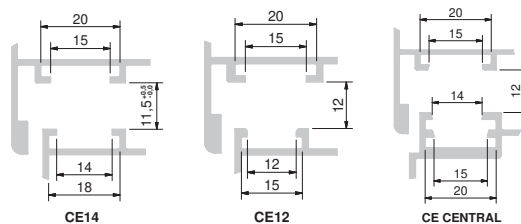



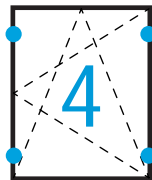

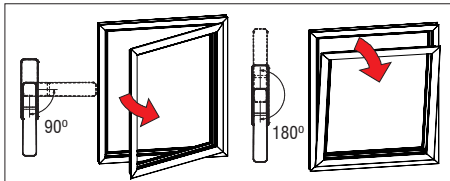

ORIZON TILT AND TURN



OBO7

REF.	DESIGNATION	UNITS	PACKING	PACK.GR.	OBSERVATIONS
	OBO7 Soft Tilt and turn Basic Kit (4 Locking Points)	UN	1	1115	
	OBO7K Soft Tilt and turn Basic Kit w/ Cremona w/ Key (4 Locking Points)	UN	1	1136	 normal opening
	OBO7P Soft Tilt and turn Basic Kit w/ Cremona w/o Handle (4 Locking Points)	UN	1	1052	 Standard EN 13126  Handle for OBO7P - 78P (Chapter Orizon Line - P. B2)

Accessories OBO7

REF.	DESIGNATION	UNITS	PACKING	PACK.GR.	FINISHING	OBSERVATIONS
	CPEQSC Soft Compass - Small Arm	UN	1	238	Zinc	(435-700)
	CGDESC Soft Compass - Big Arm	UN	1	331	Zinc	(563-1000)
	CSUP Additional Arm	UN	1	243	Stainless Steel	1000<L<1700mm
	KITH/VSC Soft H/V Additional Locking Set	UN	20	-	Zinc	-
	PFSUPSC 18256 Soft Additional Locking Point Set	UN	50	-	Zinc	-



Accessories OBO7

	REF.	DESIGNATION	UNITS	PACKING	PACK.GR.	FINISHING	OBSERVATIONS
	OBG2	Passive Leaf Hinge Set	UN	5	2376	Powder Painting	With regulation
	MICROVEN	Microventilation Set	UN	20	1099	Zinc	With air intake regulation
	33051	Passive Leaf Bi-directional Locking Drive Set w/ Simple Zamak Terminal	UN	10	3009	Zinc	-
	FALAV 18219	Passive Leaf Zamak Lock Set	UN	5	2115	Zinc	In Zamak EG14 Only
	FECRAMPA	Adjustable Hidden Lock Ramp	UN	50	1316	Zinc	-
	CAJUSTE 18221	Leaf Support	UN	50	503	Black Nylon	-
	L150	Regulable Limiting Arm w/ 150mm	UN	40	3378	Powder Painting	With pressure regulation. Stainless Steel Bolt
	L220	Regulable Limiting Arm w/ 220mm	UN	60	5538	Powder Painting	With pressure regulation. Stainless Steel Bolt
	L300	Regulable Limiting Arm w/ 300mm	UN	40	4162	Powder Painting	With pressure regulation. Stainless Steel Bolt



ORIZON TILT AND TURN

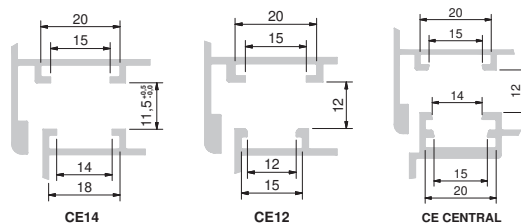

OBO7+ (PLUS)

REF.	DESIGNATION	UNITS	PACKING	PACK.GR.	OBSERVATIONS
	OBO7+ Soft Tilt and turn Kit (6 Locking Points)	UN	1	1257	
	OBO7K+ Soft Tilt and turn Kit w/ Cremona w/ Key (6 Locking Points)	UN	1	1278	
	OBO7+P Soft Tilt and turn Kit w/ Cremona w/o Handle (6 Locking Points)	UN	1	1194	 Standard EN 13126 Handle for OBO7+P - 78P (Chapter Orizon Line - P. B2)

Accessories OBO7+ (PLUS)

REF.	DESIGNATION	UNITS	PACKING	PACK.GR.	FINISHING	OBSERVATIONS
	CPEQSC Soft Compass - Small Arm	UN	1	238	Zinc	(435-700)
	CGDESC Soft Compass - Big Arm	UN	1	331	Zinc	(563-1000)
	CSUP Additional Arm	UN	1	243	Stainless Steel	1000<L<1700mm
	KITH/VSC Soft H/V Additional Locking Set	UN	20	-	Zinc	-
	PFSUPSC 18256 Soft Additional Locking Point Set	UN	50	-	Zinc	-



Accessories OBO7+ (PLUS)





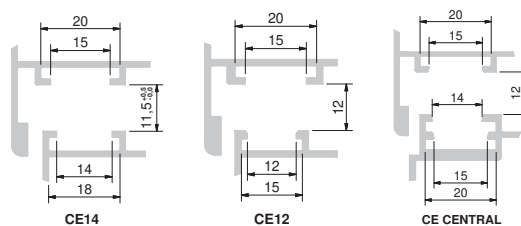

	REF.	DESIGNATION	UNITS	PACKING	PACK.GR.	FINISHING	OBSERVATIONS
	OBG2	Passive Leaf Hinge Set	UN	5	2376	Powder Painting	With regulation
	MICROVEN	Microventilation Set	UN	20	1099	Zinc	With air intake regulation
	33051	Passive Leaf Bi-directional Locking Drive Set w/ Simple Zamak Terminal	UN	10	3009	Zinc	-
	FALAVML 18246	Passive Leaf Zamak Lock Set	UN	5	2086	Zinc	In Zamak EG14 Only
	FECRAMPA	Adjustable Hidden Lock Ramp	UN	50	1316	Zinc	-
	CAJUSTE 18221	Leaf Support	UN	50	503	Black Nylon	-
	L150	Regulable Limiting Arm w/ 150mm	UN	40	3378	Powder Painting	With pressure regulation. Stainless Steel Bolt
	L220	Regulable Limiting Arm w/ 220mm	UN	60	5538	Powder Painting	With pressure regulation. Stainless Steel Bolt
	L300	Regulable Limiting Arm w/ 300mm	UN	40	4162	Powder Painting	With pressure regulation. Stainless Steel Bolt



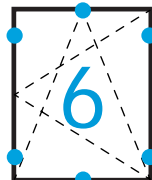

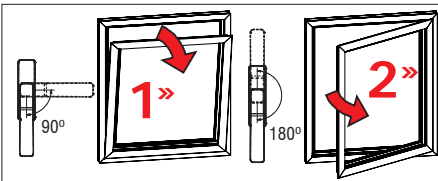

ORIZON TILT AND TURN



OBO7+ (LOGIC)

REF.	DESIGNATION	UNITS	PACKING	PACK.GR.	OBSERVATIONS
	OBO7+ Soft Tilt and turn Kit (6 Locking Points)	UN	1	1257	
	OBO7K+ Soft Tilt and turn Kit w/ Cremona w/ Key (6 Locking Points)	UN	1	1278	 opening logic maneuver
	OBO7+P Soft Tilt and turn Kit w/ Cremona w/o Handle (6 Locking Points)	UN	1	1194	 Standard EN 13126  Handle for OBO7+P - 78P (Chapter Orizon Line - P. B2)

Accessories OBO7+ (LOGIC)

REF.	DESIGNATION	UNITS	PACKING	PACK.GR.	FINISHING	OBSERVATIONS
	CPEQMLSC Soft TBT Compass - Small Arm	UN	1	236	Zinc	(435-700)
	CGDEMLSC Soft TBT Compass - Big Arm	UN	1	328	Zinc	(563-1000)
	CSUPML Additional Arm	UN	1	243	Stainless Steel	1000<L<1700mm
	KITH/VSC Soft H/V Additional Locking Set	UN	20	-	Zinc	-
	PFSUPSC 18256 Soft Additional Locking Point Set	UN	50	-	Zinc	-



Accessories OBO7+ (LOGIC)





	REF.	DESIGNATION	UNITS	PACKING	PACK.GR.	FINISHING	OBSERVATIONS
	OBG2	Passive Leaf Hinge Set	UN	5	2376	Powder Painting	With regulation
	MICROVEN	Microventilation Set	UN	20	1099	Zinc	With air intake regulation
	33051	Passive Leaf Bi-directional Locking Drive Set w/ Simple Zamak Terminal	UN	10	3009	Zinc	-
	FALAVML 18246	Passive Leaf Zamak Lock Set	UN	5	2086	Zinc	In Zamak EG14 Only
	FECRAMPA	Adjustable Hidden Lock Ramp	UN	50	1316	Zinc	-
	CAJUSTE 18221	Leaf Support	UN	50	503	Black Nylon	-
	L150	Regulable Limiting Arm w/ 150mm	UN	40	3378	Powder Painting	With pressure regulation. Stainless Steel Bolt
	L220	Regulable Limiting Arm w/ 220mm	UN	60	5538	Powder Painting	With pressure regulation. Stainless Steel Bolt
	L300	Regulable Limiting Arm w/ 300mm	UN	40	4162	Powder Painting	With pressure regulation. Stainless Steel Bolt

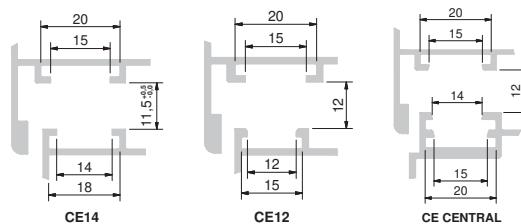



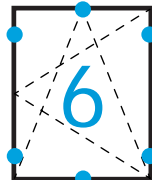
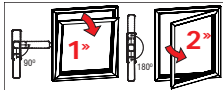



ERIZON TILT AND TURN



OBO7+S (LOGIC)

REF.	DESIGNATION	UNITS	PACKING	PACK.GR.	OBSERVATIONS
	OBO+SD Soft Tilt before turn Kit (Right) w/ Security Key Cremona (6 Locking Points)	UN	1	1271	  Only tilts when locked Opens only unlocked
	OBO+SE Soft Tilt before turn Kit (Left) w/ Security Key Cremona (6 Locking Points)	UN	1	1271	 Standard EN 13126 

Accessories OBO7+S (LOGIC)

REF.	DESIGNATION	UNITS	PACKING	PACK.GR.	FINISHING	OBSERVATIONS
	CPEQMLSC Soft TBT Compass - Small Arm	UN	1	236	Zinc	(435-700)
	CGDEMLSC Soft TBT Compass - Big Arm	UN	1	328	Zinc	(563-1000)
	CSUPML Additional Arm	UN	1	243	Stainless Steel	1000<L<1700mm
	KITH/VSC Soft H/V Additional Locking Set	UN	20	-	Zinc	-
	PFSUPSC 18256 Soft Additional Locking Point Set	UN	50	-	Zinc	-
	OBG2 Passive Leaf Hinge Set	UN	5	2376	Powder Painting	With regulation



Accessories OBO7+S (LOGIC)

REF.	DESIGNATION	UNITS	PACKING	PACK.GR.	FINISHING	OBSERVATIONS	
	MICROVEN	Microventilation Set	UN	20	1099	Zinc	With air intake regulation
	33051	Passive Leaf Bi-directional Locking Drive Set w/ Simple Zamak Terminal	UN	10	3009	Zinc	-
	FALAVML 18246	Passive Leaf Zamak Lock Set	UN	5	2086	Zinc	In Zamak EG14 Only
	FECRAMPA	Adjustable Hidden Lock Ramp	UN	50	1316	Zinc	-
	CAJUSTE 18221	Leaf Support	UN	50	503	Black Nylon	-
	L150	Regulable Limiting Arm w/ 150mm	UN	40	3378	Powder Painting	With pressure regulation. Stainless Steel Bolt
	L220	Regulable Limiting Arm w/ 220mm	UN	60	5538	Powder Painting	With pressure regulation. Stainless Steel Bolt
	L300	Regulable Limiting Arm w/ 300mm	UN	40	4162	Powder Painting	With pressure regulation. Stainless Steel Bolt



ERIZON TILT AND TURN

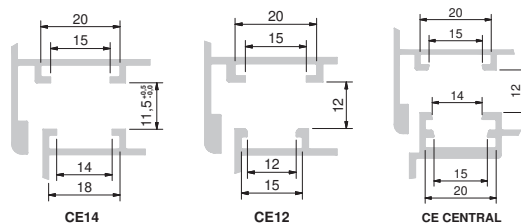

OBO7G

REF.	DESIGNATION	UNITS	PACKING	PACK.GR.	OBSERVATIONS
	OBO7G Soft Tilt and turn Basic Kit f/ Gearbox (4 Locking Points)	UN	1	1115	 Gearbox Mechanism sold separately.
	OBO7GK Soft Tilt and turn Basic Kit w/ Handle w/ Key f/ Gearbox (4 Locking Points)	UN	1	1136	 normal opening Standard EN 13126

Accessories OBO7G

REF.	DESIGNATION	UNITS	PACKING	PACK.GR.	FINISHING	OBSERVATIONS
	9322 Gearbox Mechanism (7mm Axis)	UN	10	-	Zinc	-
	9323 Gearbox Mechanism (11mm Axis)	UN	10	-	Zinc	-
	9324 Gearbox Mechanism (13,5mm Axis)	UN	10	-	Zinc	-
	CPEQSC Soft Compass - Small Arm	UN	1	238	Zinc	(435-700)
	CGDESC Soft Compass - Big Arm	UN	1	331	Zinc	(563-1000)
	CSUP Additional Arm	UN	1	243	Stainless Steel	1000<L<1700mm
	KITH/VSC Soft H/V Additional Locking Set	UN	20	-	Zinc	-



Accessories OBO7G





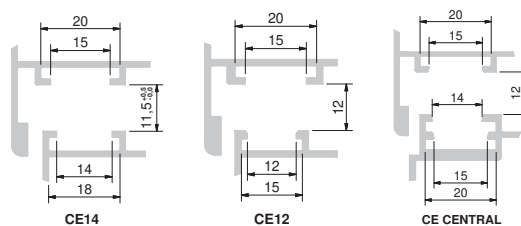

	REF.	DESIGNATION	UNITS	PACKING	PACK.GR.	FINISHING	OBSERVATIONS
	PFSUPSC 18256	Soft Additional Locking Point Set	UN	50	-	Zinc	-
	OBG2	Passive Leaf Hinge Set	UN	5	2376	Powder Painting	With regulation
	MICROVEN	Microventilation Set	UN	20	1099	Zinc	With air intake regulation
	33051	Passive Leaf Bi-directional Locking Drive Set w/ Simple Zamak Terminal	UN	10	3009	Zinc	-
	FALAV 18219	Passive Leaf Zamak Lock Set	UN	5	2115	Zinc	In Zamak EG14 Only
	FECRAMPA	Adjustable Hidden Lock Ramp	UN	50	1316	Zinc	-
	CAJUSTE 18221	Leaf Support	UN	50	503	Black Nylon	-
	L150	Regulable Limiting Arm w/ 150mm	UN	40	3378	Powder Painting	With pressure regulation. Stainless Steel Bolt
	L220	Regulable Limiting Arm w/ 220mm	UN	60	5538	Powder Painting	With pressure regulation. Stainless Steel Bolt
	L300	Regulable Limiting Arm w/ 300mm	UN	40	4162	Powder Painting	With pressure regulation. Stainless Steel Bolt



ERIZON TILT AND TURN

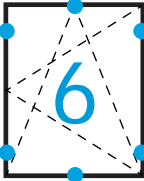

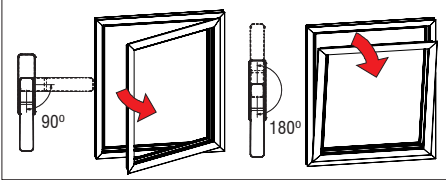
OBO7G+ (PLUS)









REF.	DESIGNATION	UNITS	PACKING	PACK.GR.	OBSERVATIONS
	OBO7G+ Soft Tilt and turn Kit f/ Gearbox (6 Locking Points)	UN	1	1257	 <p>Gearbox Mechanism sold separately.</p> 
	OBO7GK+ Soft Tilt and turn Kit w/ Handle w/ Key f/ Gearbox (6 Locking Points)	UN	1	1278	 <p>normal opening</p>  <p>130 kg</p> <p>Standard EN 13126</p> 

Accessories OBO7G+ (PLUS)

REF.	DESIGNATION	UNITS	PACKING	PACK.GR.	FINISHING	OBSERVATIONS
	9322 Gearbox Mechanism (7mm Axis)	UN	10	-	Zinc	-
	9323 Gearbox Mechanism (11mm Axis)	UN	10	-	Zinc	-
	9324 Gearbox Mechanism (13,5mm Axis)	UN	10	-	Zinc	-
	CPEQSC Soft Compass - Small Arm	UN	1	238	Zinc	(435-700)
	CGDESC Soft Compass - Big Arm	UN	1	331	Zinc	(563-1000)
	CSUP Additional Arm	UN	1	243	Stainless Steel	1000<L<1700mm
	KITH/VSC Soft H/V Additional Locking Set	UN	20	-	Zinc	-



Accessories OBO7G+ (PLUS)





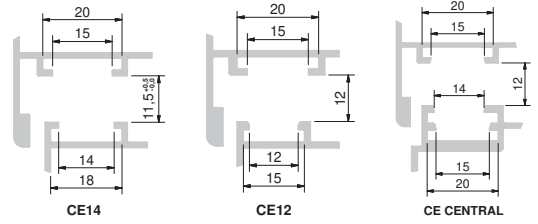

	REF.	DESIGNATION	UNITS	PACKING	PACK.GR.	FINISHING	OBSERVATIONS
	PFSUPSC 18256	Soft Additional Locking Point Set	UN	50	-	Zinc	-
	OBG2	Passive Leaf Hinge Set	UN	5	2376	Powder Painting	With regulation
	MICROVEN	Microventilation Set	UN	20	1099	Zinc	With air intake regulation
	33051	Passive Leaf Bi-directional Locking Drive Set w/ Simple Zamak Terminal	UN	10	3009	Zinc	-
	FALAVML 18246	Passive Leaf Zamak Lock Set	UN	5	2086	Zinc	In Zamak EG14 Only
	FECRAMPA	Adjustable Hidden Lock Ramp	UN	50	1316	Zinc	-
	CAJUSTE 18221	Leaf Support	UN	50	503	Black Nylon	-
	L150	Regulable Limiting Arm w/ 150mm	UN	40	3378	Powder Painting	With pressure regulation. Stainless Steel Bolt
	L220	Regulable Limiting Arm w/ 220mm	UN	60	5538	Powder Painting	With pressure regulation. Stainless Steel Bolt
	L300	Regulable Limiting Arm w/ 300mm	UN	40	4162	Powder Painting	With pressure regulation. Stainless Steel Bolt



ERIZON TILT AND TURN

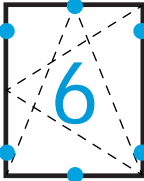

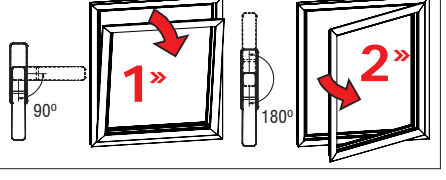
OBO7G+ (LOGIC)





REF.	DESIGNATION	UNITS	PACKING	PACK.GR.	OBSERVATIONS
	OBO7G+ Soft Tilt and turn Kit f/ Gearbox (6 Locking Points)	UN	1	1257	 Gearbox Mechanism sold separately. 
	OBO7GK+ Soft Tilt and turn Kit w/ Handle w/ Key f/ Gearbox (6 Locking Points)	UN	1	1278	 opening logic maneuver  Standard EN 13126 

Accessories OBO7G+ (LOGIC)

REF.	DESIGNATION	UNITS	PACKING	PACK.GR.	FINISHING	OBSERVATIONS
	9322 Gearbox Mechanism (7mm Axis)	UN	10	-	Zinc	-
	9323 Gearbox Mechanism (11mm Axis)	UN	10	-	Zinc	-
	9324 Gearbox Mechanism (13,5mm Axis)	UN	10	-	Zinc	-
	CPEQMLSC Soft TBT Compass - Small Arm	UN	1	236	Zinc	(435-700)
	CGDEMLSC Soft TBT Compass - Big Arm	UN	1	328	Zinc	(563-1000)
	CSUPML Additional Arm	UN	1	243	Stainless Steel	1000<L<1700mm
	KITH/VSC Soft H/V Additional Locking Set	UN	20	-	Zinc	-



Accessories OBO7G+ (LOGIC)

	REF.	DESIGNATION	UNITS	PACKING	PACK.GR.	FINISHING	OBSERVATIONS
	PFSUPSC 18256	Soft Additional Locking Point Set	UN	50	-	Zinc	-
	OBG2	Passive Leaf Hinge Set	UN	5	2376	Powder Painting	With regulation
	MICROVEN	Microventilation Set	UN	20	1099	Zinc	With air intake regulation
	33051	Passive Leaf Bi-directional Locking Drive Set w/ Simple Zamak Terminal	UN	10	3009	Zinc	-
	FALAVML 18246	Passive Leaf Zamak Lock Set	UN	5	2086	Zinc	In Zamak EG14 Only
	FECRAMPA	Adjustable Hidden Lock Ramp	UN	50	1316	Zinc	-
	CAJUSTE 18221	Leaf Support	UN	50	503	Black Nylon	-
	L150	Regulable Limiting Arm w/ 150mm	UN	40	3378	Powder Painting	With pressure regulation. Stainless Steel Bolt
	L220	Regulable Limiting Arm w/ 220mm	UN	60	5538	Powder Painting	With pressure regulation. Stainless Steel Bolt
	L300	Regulable Limiting Arm w/ 300mm	UN	40	4162	Powder Painting	With pressure regulation. Stainless Steel Bolt



ERIZON TILT AND TURN

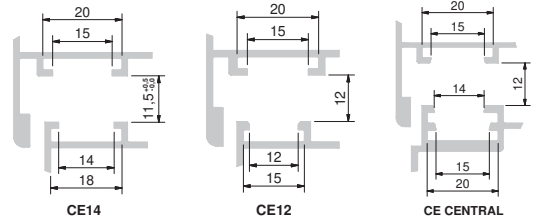

OBO7G+S (LOGIC)

REF.	DESIGNATION	UNITS	PACKING	PACK.GR.	OBSERVATIONS
	OBO7G+SD Soft Tilt before turn Kit (Right) w/ Security Key Handle f/ Gearbox (6 Locking Points)	UN	1	1271	<p>Gearbox Mechanism sold separately.</p>
	OBO7G+SE Soft Tilt before turn Kit (Left) w/ Security Key Handle f/ Gearbox (6 Locking Points)	UN	1	1271	Only tilts when locked opening logic maneuver Opens only unlocked 130 kg Standard EN 13126

Accessories OBO7G+S (LOGIC)

REF.	DESIGNATION	UNITS	PACKING	PACK.GR.	FINISHING	OBSERVATIONS
	9322 Gearbox Mechanism (7mm Axis)	UN	10	-	Zinc	-
	9323 Gearbox Mechanism (11mm Axis)	UN	10	-	Zinc	-
	9324 Gearbox Mechanism (13,5mm Axis)	UN	10	-	Zinc	-
	CPEQMLSC Soft TBT Compass - Small Arm	UN	1	236	Zinc	(435-700)
	CGDEMLSC Soft TBT Compass - Big Arm	UN	1	328	Zinc	(563-1000)
	CSUPML Additional Arm	UN	1	243	Stainless Steel	1000<L<1700mm
	KITH/VSC Soft H/V Additional Locking Set	UN	20	-	Zinc	-



Accessories OBO7G+S (LOGIC)





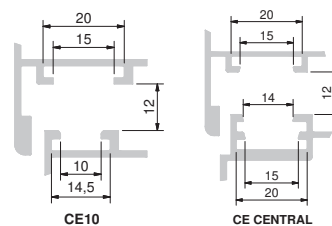

	REF.	DESIGNATION	UNITS	PACKING	PACK.GR.	FINISHING	OBSERVATIONS
	PFSUPSC 18256	Soft Additional Locking Point Set	UN	50	-	Zinc	-
	OBG2	Passive Leaf Hinge Set	UN	5	2376	Powder Painting	With regulation
	MICROVEN	Microventilation Set	UN	20	1099	Zinc	With air intake regulation
	33051	Passive Leaf Bi-directional Locking Drive Set w/ Simple Zamak Terminal	UN	10	3009	Zinc	-
	FALAVML 18246	Passive Leaf Zamak Lock Set	UN	5	2086	Zinc	In Zamak EG14 Only
	FECRAMPA	Adjustable Hidden Lock Ramp	UN	50	1316	Zinc	-
	CAJUSTE 18221	Leaf Support	UN	50	503	Black Nylon	-
	L150	Regulable Limiting Arm w/ 150mm	UN	40	3378	Powder Painting	With pressure regulation. Stainless Steel Bolt
	L220	Regulable Limiting Arm w/ 220mm	UN	60	5538	Powder Painting	With pressure regulation. Stainless Steel Bolt
	L300	Regulable Limiting Arm w/ 300mm	UN	40	4162	Powder Painting	With pressure regulation. Stainless Steel Bolt



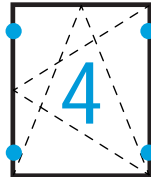

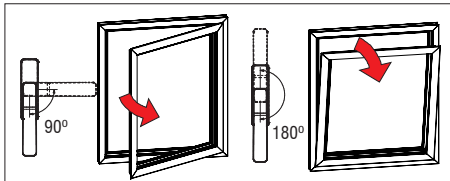

ORIZON TILT AND TURN



OBO7C10





REF.	DESIGNATION	UNITS	PACKING	PACK.GR.	OBSERVATIONS
	OBO7C10 Soft Tilt and turn Basic Kit C10 (4 Locking Points)	UN	1	1115	
	OBO7KC10 Soft Tilt and turn Basic Kit C10 w/ Cremona w/ Key (4 Locking Points)	UN	1	1136	 normal opening
	OBO7PC10 Soft Tilt and turn Basic Kit C10 w/ Cremona w/o Handle (4 Locking Points)	UN	1	1052	 Standard EN 13126  Handle for OBO7PC10 - 78P (Chapter Orizon Line - P. B2)

Accessories OBO7C10

REF.	DESIGNATION	UNITS	PACKING	PACK.GR.	FINISHING	OBSERVATIONS
	CPEQSC Soft Compass - Small Arm	UN	1	238	Zinc	(435-700)
	CGDESC Soft Compass - Big Arm	UN	1	331	Zinc	(563-1000)
	CSUP Additional Arm	UN	1	243	Stainless Steel	1000<L<1700mm
	KITH/VSC 18287 Soft H/V Additional Locking Set	UN	20	-	Zinc	-



Accessories OBO7C10





	REF.	DESIGNATION	UNITS	PACKING	PACK.GR.	FINISHING	OBSERVATIONS
	PFSUPSC 18257	Soft Additional Locking Point Set	UN	50	-	Zinc	-
	OBG2	Passive Leaf Hinge Set	UN	5	2376	Powder Painting	With regulation
	33051	Passive Leaf Bi-directional Locking Drive Set w/ Simple Zamak Terminal	UN	10	3009	Zinc	-
	CAJUSTE 18221	Leaf Support	UN	50	503	Black Nylon	-
	L150	Regulable Limiting Arm w/ 150mm	UN	40	3378	Powder Painting	With pressure regulation. Stainless Steel Bolt
	L220	Regulable Limiting Arm w/ 220mm	UN	60	5538	Powder Painting	With pressure regulation. Stainless Steel Bolt
	L300	Regulable Limiting Arm w/ 300mm	UN	40	4162	Powder Painting	With pressure regulation. Stainless Steel Bolt

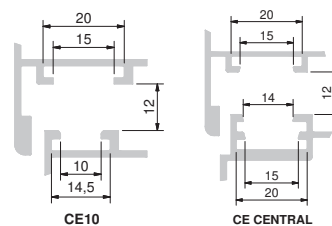



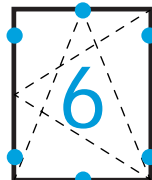
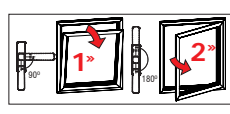

ERIZON TILT AND TURN



OBO7+SC10 (LOGIC)

REF.	DESIGNATION	UNITS	PACKING	PACK.GR.	OBSERVATIONS
	OBO+SDC10 Soft Tilt before turn Kit (Right) w/ Security Key Cremona (6 Locking Points)	UN	1	1271	  <p>Only tilts when locked</p> <p>Opens only unlocked</p>
	OBO+SEC10 Soft Tilt before turn Kit (Left) w/ Security Key Cremona (6 Locking Points)	UN	1	1271	  <p>Standard EN 13126</p>

Accessories OBO7+SC10 (LOGIC)

REF.	DESIGNATION	UNITS	PACKING	PACK.GR.	FINISHING	OBSERVATIONS
	CPEQMLSC Soft TBT Compass - Small Arm	UN	1	236	Zinc	(435-700)
	CGDEMLSC Soft TBT Compass - Big Arm	UN	1	328	Zinc	(563-1000)
	CSUPML Additional Arm	UN	1	243	Stainless Steel	1000<L<1700mm
	KITH/VSC 18287 Soft H/V Additional Locking Set	UN	20	-	Zinc	-
	PFSUPSC 18257 Soft Additional Locking Point Set	UN	50	-	Zinc	-



Accessories OBO7+SC10 (LOGIC)







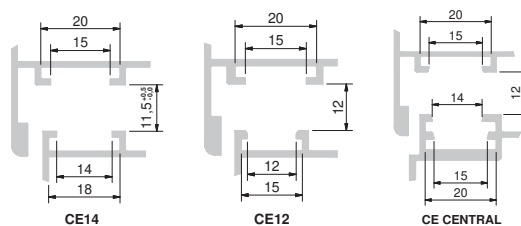

REF.	DESIGNATION	UNITS	PACKING	PACK.GR.	FINISHING	OBSERVATIONS	
	OBG2	Passive Leaf Hinge Set	UN	5	2376	Powder Painting	With regulation
	33051	Passive Leaf Bi-directional Locking Drive Set w/ Simple Zamak Terminal	UN	10	3009	Zinc	-
	CAJUSTE 18221	Leaf Support	UN	50	503	Black Nylon	-
	L150	Regulable Limiting Arm w/ 150mm	UN	40	3378	Powder Painting	With pressure regulation. Stainless Steel Bolt
	L220	Regulable Limiting Arm w/ 220mm	UN	60	5538	Powder Painting	With pressure regulation. Stainless Steel Bolt
	L300	Regulable Limiting Arm w/ 300mm	UN	40	4162	Powder Painting	With pressure regulation. Stainless Steel Bolt





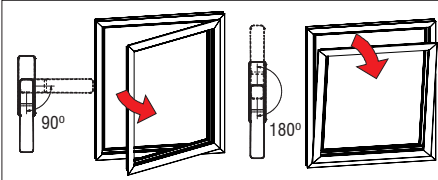

ERIZON
TILT AND TURN



OBO7GC10





REF.	DESIGNATION	UNITS	PACKING	PACK.GR.	OBSERVATIONS
	 OBO7GC10 Soft Tilt and turn Basic Kit f/ Gearbox (4 Locking Points)	UN	1	1115	 Gearbox Mechanism sold separately. 
	 OBO7GKC10 Soft Tilt and turn Basic Kit w/ Handle w/ Key f/ Gearbox (4 Locking Points)	UN	1	1136	 normal opening  1.30 kg Standard EN 13126 

Accessories OBO7GC10

REF.	DESIGNATION	UNITS	PACKING	PACK.GR.	FINISHING	OBSERVATIONS	
	9322	Gearbox Mechanism (7mm Axis)	UN	10	-	Zinc	-
	9323	Gearbox Mechanism (11mm Axis)	UN	10	-	Zinc	-
	9324	Gearbox Mechanism (13,5mm Axis)	UN	10	-	Zinc	-
	CPEQSC	Soft Compass - Small Arm	UN	1	238	Zinc	(435-700)
	CGDESC	Soft Compass - Big Arm	UN	1	331	Zinc	(563-1000)
	CSUP	Additional Arm	UN	1	243	Stainless Steel	1000<L<1700mm
	KITH/VSC 18287	Soft H/V Additional Locking Set	UN	20	-	Zinc	-















Accessories OBO7GC10

	REF.	DESIGNATION	UNITS	PACKING	PACK.GR.	FINISHING	OBSERVATIONS
	PFSUPSC 18257	Soft Additional Locking Point Set	UN	50	-	Zinc	-
	OBG2	Passive Leaf Hinge Set	UN	5	2376	Powder Painting	With regulation
	33051	Passive Leaf Bi-directional Locking Drive Set w/ Simple Zamak Terminal	UN	10	3009	Zinc	-
	CAJUSTE 18221	Leaf Support	UN	50	503	Black Nylon	-
	L150	Regulable Limiting Arm w/ 150mm	UN	40	3378	Powder Painting	With pressure regulation. Stainless Steel Bolt
	L220	Regulable Limiting Arm w/ 220mm	UN	60	5538	Powder Painting	With pressure regulation. Stainless Steel Bolt
	L300	Regulable Limiting Arm w/ 300mm	UN	40	4162	Powder Painting	With pressure regulation. Stainless Steel Bolt



2020 AWARDS

ERIZON
LINE









REF.	DESIGNATION	UNITS	PACKING	PACK.GR.	FINISHING	OBSERVATIONS
 740	Cremona for Euro Groove (Euro Fixation)	UN	12	4263	Powder Painting	Also available w/ M and L nails
 740K	Cremona for Euro Groove w/ Key (Euro Fixation)	UN	10	3796	Powder Painting	Also available w/ M and L nails  Equal keys
 710	Cremona for Euro Groove (Frontal Fixation)	UN	12	3415	Powder Painting	Also available w/ M and L nails
 710K	Cremona for Euro Groove w/ Key (Frontal Fixation)	UN	10	3400	Powder Painting	Also available w/ M and L nails  Equal keys
 730	Lower Cremona for Euro Groove (Frontal Fixation)	UN	10	2584	Powder Painting	Also available w/ M and L nails
 719D	Right Offset Handle Cremona for Euro Groove (Frontal Fixation)	UN	12	3415	Powder Painting	Also available w/ M and L nails
 719E	Left Offset Handle Cremona for Euro Groove (Frontal Fixation)	UN	12	3415	Powder Painting	Also available w/ M and L nails
 760	Cremona for Curtain Wall (Euro Fixation)	UN	12	4755	Powder Painting	Also available w/ M and L nails
 760K	Cremona for Curtain Wall w/ Key (Euro Fixation)	UN	12	4995	Powder Painting	Also available w/ M and L nails  Equal keys

NOTE: Nails M (27mm) and L (37mm) +0,15€.
Included screws except where indicated.



GRIZON
LINE



REF.	DESIGNATION	UNITS	PACKING	PACK.GR.	FINISHING	OBSERVATIONS
	780 Security Cremona for Euro Groove w/o Handle (Euro Fixation)	UN	10	2371	Powder Painting	Also available w/ M and L nails
	78P Detachable Handle for 780 and 785 Cremona	UN	10	1200	Powder Painting	-
	770 Security Cremona for Euro Groove w/o Handle (Frontal Fixation)	UN	10	2176	Powder Painting	Also available w/ M and L nails
	77P Detachable Handle for 770 Cremona	UN	10	821	Powder Painting	-
	745S Cremona for Tilt-turn Euro Groove - 12mm Nail (Euro Fixation)	UN	10	3400	Powder Painting	-
	745SK Cremona for Tilt-turn Euro Groove w/ Key - 12mm Nail (Euro Fixation)	UN	10	3627	Powder Painting	 Equal keys
	735S Lower Cremona for Tilt-turn Euro Groove - 12mm Nail (Frontal Fixation)	UN	10	2584	Powder Painting	-
	785S Security Cremona for Tilt-turn Euro Groove w/o Handle - 12mm Nail (Euro Fixation)	UN	10	2371	Powder Painting	-

NOTE: Nails M (27mm) and L (37mm) +0,15€.
Included screws except where indicated.

The total or partial reproduction of this list is forbidden without the authorization of ALUALPHA S. A.













Other colors see page 1



2020
AWARDS



ERIZON
LINE











REF.	DESIGNATION	UNITS	PACKING	PACK.GR.	FINISHING	OBSERVATIONS	
	748	Minimalist Handle 3 Positions (Square of 7x32mm)	UN	10	-	Powder Painting	-
	748K	Minimalist Handle 3 Positions w/ Key (Square of 7x32mm)	UN	10	-	Powder Painting	 Equal keys
	708	Handle 3 Positions (Square of 7x32mm)	UN	10	2948	Powder Painting	Also available w/ Square of 7x23mm and 7x60mm
	708K	Handle 3 Positions w/ Key (Square of 7x32mm)	UN	10	2948	Powder Painting	Also available w/ Square of 7x23mm and 7x60mm  Equal keys
	708DO	Double Handle 3 Positions	PAIRS	6	3134	Powder Painting	 Fixation Kit: KIT-33056 » 22 to 33mm Profile KIT-33057 » 33 to 45mm Profile
	709D	Right Offset Handle 3 Positions (Square of 7x32mm)	UN	10	3155	Powder Painting	Also available w/ Square of 7x23mm and 7x60mm
	709E	Left Offset Handle 3 Positions (Square of 7x32mm)	UN	10	3155	Powder Painting	Also available w/ Square of 7x23mm and 7x60mm
	709DO	Double Offset Handle 3 Positions	PAIRS	6	3384	Powder Painting	 Fixation Kit: KIT-33056 » 22 to 33mm Profile KIT-33057 » 33 to 45mm Profile
	794	Handle 3 Positions (Square of 7x32mm)	UN	10	3166	Powder Painting	Also available w/ Square of 7x23mm and 7x60mm

NOTE: Square of 7x60mm +0,15€.
Included screws except where indicated.



ERIZON
LINE



REF.	DESIGNATION	UNITS	PACKING	PACK.GR.	FINISHING	OBSERVATIONS
 9326	 Flush Handle 3 Positions (Square of 7x32mm)	UN	10	-	Powder Painting	Also available w/ Square of 7x23mm and 7x60mm
702	 Pull Handle w/ Cam Drive	UN	10	-	Powder Painting	Fixing: aluminium crimping nuts
700	 Pull Handle	UN	10	-	Powder Painting	Fixing: aluminium crimping nuts
715	 Double Spring-loaded Handle for Doors (Square of 8x100mm)	PAIRS	12	6904	Powder Painting	Also available w/ Square of 8x140mm
715ND	 Right Double Spring-loaded Handle for Doors (Square of 8x100mm)	PAIRS	12	6900	Powder Painting	Fixing to the exterior handle Also available w/ Square of 8x140mm
715NZ	 Left Double Spring-loaded Handle for Doors (Square of 8x100mm)	PAIRS	12	6900	Powder Painting	Fixing to the exterior handle Also available w/ Square of 8x140mm
715iD	 Right Spring-loaded Handle for Doors (Square of 8x100mm)	UN	20	-	Powder Painting	Also available w/ Square of 8x140mm
715iZ	 Left Spring-loaded Handle for Doors (Square of 8x100mm)	UN	20	-	Powder Painting	Also available w/ Square of 8x140mm
705T	 Double Slim Spring-loaded Handle w/ Caps for Doors (Square of 8x100mm)	PAIRS	6	2404	Powder Painting	Also available w/ Square of 8x140mm
706T	 Lower Double Slim Spring- loaded Handle w/ Caps for Doors (Square of 8x100mm)	PAIRS	6	2169	Powder Painting	Also available w/ Square of 8x140mm

NOTE: Square of 8x140mm +0,15€.

Included screws except where indicated.







The total or partial reproduction of this list is forbidden without the authorization of ALUALPHA S. A.

Other colors see page 1



2020 AWARDS

ERIZON
LINE

	REF.	DESIGNATION	UNITS	PACKING	PACK.GR.	FINISHING	OBSERVATIONS
	33050	Lock Shield for Cylinder	UN	25	1578	Powder Painting	-
	716B	Double Long Blind Mirror Handle for Doors (Square of 8x100mm)	PAIRS	6	5755	Powder Painting	-
	716BiD	Right Long Blind Mirror Handle for Doors (Square of 8x100mm)	UN	10	-	Powder Painting	-
	716BiZ	Left Long Blind Mirror Handle for Doors (Square of 8x100mm)	UN	10	-	Powder Painting	-
	716	Double Long Mirror Handle for Doors for Cylinder (Square of 8x100mm)	PAIRS	6	5710	Powder Painting	Distance from the axle to the cylinder of 85mm
	716iD	Right Long Mirror Handle for Doors for Cylinder (Square of 8x100mm)	UN	10	-	Powder Painting	Distance from the axle to the cylinder of 85mm
	716iZ	Left Long Mirror Handle for Doors for Cylinder (Square of 8x100mm)	UN	10	-	Powder Painting	Distance from the axle to the cylinder of 85mm
	717	Double Long Mirror Handle for Doors for Cylinder (Square of 8x100mm)	PAIRS	6	5710	Powder Painting	Distance from the axle to the cylinder of 92mm

NOTE: Included screws except where indicated.

The total or partial reproduction of this list is forbidden without the authorization of ALUALPHA S. A.

Other colors see page 1



ORIZON
LINE



REF.	DESIGNATION	UNITS	PACKING	PACK.GR.	FINISHING	OBSERVATIONS	
	717iD	Right Long Mirror Handle for Doors for Cylinder (Square of 8x100mm)	UN	10	-	Powder Painting	Distance from the axle to the cylinder of 92mm
	717iZ	Left Long Mirror Handle for Doors for Cylinder (Square of 8x100mm)	UN	10	-	Powder Painting	Distance from the axle to the cylinder of 92mm
	790	Heavy Handle for Sliding Doors for Cylinder (Square of 8x100mm)	UN	10	-	Powder Painting	-
	790E	Outside Heavy Handle for Sliding Doors for Cylinder	UN	10	-	Powder Painting	-
	790B	Blind Heavy Handle for Sliding Doors (Square of 8x100mm)	UN	10	-	Powder Painting	-
	790BE	Outside Blind Heavy Handle for Sliding Doors	UN	10	-	Powder Painting	-
	795	Lift and Slide Handle (Square of 10x66mm)	UN	10	5729	Powder Painting	-
	795E	Outside Lift and Slide Handle	UN	10	5729	Powder Painting	-

NOTE: Included screws except where indicated.

The total or partial reproduction of this list is forbidden without the authorization of ALUALPHA S. A.

Other colors see page 1



2020 AWARDS



ERIZON
LINE

	REF.	DESIGNATION	UNITS	PACKING	PACK.GR.	FINISHING	OBSERVATIONS
	795K	Lift and Slide Handle for Cylinder (Square of 10x66mm)	UN	10	5690	Powder Painting	-
	795KE	Outside Lift and Slide Handle for Cylinder	UN	10	5690	Powder Painting	-
	793M4	Lift and Slide Recessed Finger Pull (f/ M4 Screw)	UN	10	-	Powder Painting	-
	793M5	Lift and Slide Recessed Finger Pull (f/ M5 Screw)	UN	10	-	Powder Painting	-
	793M6	Lift and Slide Recessed Finger Pull (f/ M6 Screw)	UN	10	-	Powder Painting	-
	707TE	Reversible Closing Handle w/ Caps for Outwards Opening	UN	10	2421	Powder Painting	-
	707TEK	Reversible Closing Handle w/ Key and Caps for Outwards Opening	UN	10	2645	Powder Painting	Equal keys
	707TI	Reversible Closing Handle w/ Caps for Inwards Opening	UN	10	2791	Powder Painting	-

NOTE: Included screws except where indicated.









The total or partial reproduction of this list is forbidden without the authorization of ALUALPHA S. A.

Other colors see page 1



GRIZON
LINE



REF.	DESIGNATION	UNITS	PACKING	PACK.GR.	FINISHING	OBSERVATIONS
	707TIK Reversible Closing Handle w/ Key and Caps for Inwards Opening	UN	10	3015	Powder Painting	 Equal keys
	737TE Lower Reversible Closing Handle w/ Caps for Outwards Opening	UN	10	2249	Powder Painting	-
	737TI Lower Reversible Closing Handle w/ Caps for Inwards Opening	UN	10	2594	Powder Painting	-
	712 Cremona for Outwards Opening (Frontal Fixation)	UN	8	2324	Powder Painting	-
	712K Cremona for Outwards Opening w/ Key (Frontal Fixation)	UN	8	2484	Powder Painting	 Equal keys
	732 Lower Cremona for Outwards Opening (Frontal Fixation)	UN	8	2115	Powder Painting	-
	642P7 7mm Connection Pin for 642/627	UN	16	99	Stainless Steel	-
	642P10 10mm Connection Pin for 642/627	UN	16	110	Stainless Steel	-
	642P14 14mm Connection Pin for 642/627	UN	16	125	Stainless Steel	-
	642P16 16mm Connection Pin for 642/627	UN	16	132	Stainless Steel	-
	642P20 20mm Connection Pin for 642/627	UN	16	147	Stainless Steel	-
	642P26 26mm Connection Pin for 642/627	UN	16	169	Stainless Steel	-

NOTE: Included screws except where indicated.

The total or partial reproduction of this list is forbidden without the authorization of ALUALPHA S. A.

Other colors see page 1



GLOBAL PLUS TILT AND TURN

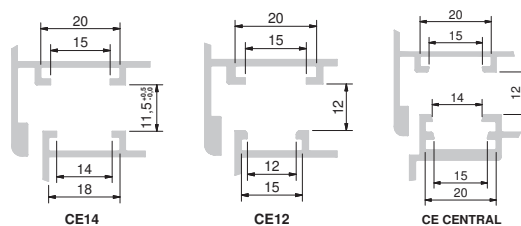

OBG60

REF.	DESIGNATION	UNITS	PACKING	PACK.GR.	OBSERVATIONS
	OBG60 Tilt and turn Basic Kit (4 Locking Points)	UN	1	-	
	OBG60K Tilt and turn Basic Kit w/ Cremona w/ Key (4 Locking Points)	UN	1	-	 normal opening Standard EN 13126

Accessories OBG60

REF.	DESIGNATION	UNITS	PACKING	PACK.GR.	FINISHING	OBSERVATIONS
	CMIC Compass - Micro Arm	UN	1	204	Zinc	(340-430)
	CMINI Compass - Mini Arm	UN	1	192	Zinc	(370-550)
	CPEQ Compass - Small Arm	UN	1	225	Zinc	(435-700)
	CGDE Compass - Big Arm	UN	1	316	Zinc	(563-1000)
	CSUP Additional Arm	UN	1	243	Stainless Steel	1000<L<1700mm
	KITH/V 18220 H/V Additional Locking Set	UN	20	2814	Zinc	-
	PFSUP 18222 Additional Adjustable Locking Point Set	UN	50	2510	Zinc	-



Accessories OBG60

	REF.	DESIGNATION	UNITS	PACKING	PACK.GR.	FINISHING	OBSERVATIONS
	OBG2	Passive Leaf Hinge Set	UN	5	2376	Powder Painting	With regulation
	MICROVEN	Microventilation Set	UN	20	1099	Zinc	With air intake regulation
	33051	Passive Leaf Bi-directional Locking Drive Set w/ Simple Zamak Terminal	UN	10	3009	Zinc	-
	FALAV 18219	Passive Leaf Zamak Lock Set	UN	5	2115	Zinc	In Zamak EG14 Only
	FECRAMPA	Adjustable Hidden Lock Ramp	UN	50	1316	Zinc	-
	CAJUSTE 18221	Leaf Support	UN	50	503	Black Nylon	-
	F2FALUM 9310	Passive Leaf Aluminium Lock Set	UN	1	93	Anodized 04	In Aluminium
	L150	Regulable Limiting Arm w/ 150mm	UN	40	3378	Powder Painting	With pressure regulation. Stainless Steel Bolt
	L220	Regulable Limiting Arm w/ 220mm	UN	60	5538	Powder Painting	With pressure regulation. Stainless Steel Bolt
	L300	Regulable Limiting Arm w/ 300mm	UN	40	4162	Powder Painting	With pressure regulation. Stainless Steel Bolt



GLOBAL PLUS TILT AND TURN

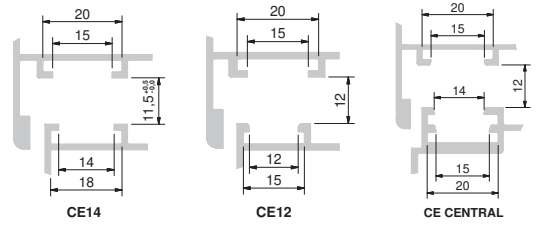

OBG60+ (PLUS)









REF.	DESIGNATION	UNITS	PACKING	PACK.GR.	OBSERVATIONS
	OBG60+ Tilt and turn Kit (6 Locking Points)	UN	1	-	
	OBG60K+ Tilt and turn Kit w/ Cremona w/ Key (6 Locking Points)	UN	1	-	<p>normal opening</p> <p>Standard EN 13126</p>

Accessories OBG60+ (PLUS)

REF.	DESIGNATION	UNITS	PACKING	PACK.GR.	FINISHING	OBSERVATIONS
	CMIC Compass - Micro Arm	UN	1	204	Zinc	(340-430)
	CMINI Compass - Mini Arm	UN	1	192	Zinc	(370-550)
	CPEQ Compass - Small Arm	UN	1	225	Zinc	(435-700)
	CGDE Compass - Big Arm	UN	1	316	Zinc	(563-1000)
	CSUP Additional Arm	UN	1	243	Stainless Steel	1000<L<1700mm
	KITH/V 18220 H/V Additional Locking Set	UN	20	2814	Zinc	-
	PFSUP 18222 Additional Adjustable Locking Point Set	UN	50	2510	Zinc	-



Accessories OBG60+ (PLUS)

REF.	DESIGNATION	UNITS	PACKING	PACK.GR.	FINISHING	OBSERVATIONS	
	OBG2	Passive Leaf Hinge Set	UN	5	2376	Powder Painting	With regulation
	MICROVEN	Microventilation Set	UN	20	1099	Zinc	With air intake regulation
	33051	Passive Leaf Bi-directional Locking Drive Set w/ Simple Zamak Terminal	UN	10	3009	Zinc	-
	FALAVML 18246	Passive Leaf Zamak Lock Set	UN	5	2086	Zinc	In Zamak EG14 Only
	FECRAMPA	Adjustable Hidden Lock Ramp	UN	50	1316	Zinc	-
	CAJUSTE 18221	Leaf Support	UN	50	503	Black Nylon	-
	F2FALUM+ 18245	Passive Leaf Aluminium Lock Set	UN	1	148	Anodized 04	In Aluminium
	L150	Regulable Limiting Arm w/ 150mm	UN	40	3378	Powder Painting	With pressure regulation. Stainless Steel Bolt
	L220	Regulable Limiting Arm w/ 220mm	UN	60	5538	Powder Painting	With pressure regulation. Stainless Steel Bolt
	L300	Regulable Limiting Arm w/ 300mm	UN	40	4162	Powder Painting	With pressure regulation. Stainless Steel Bolt



GLOBAL PLUS TILT AND TURN

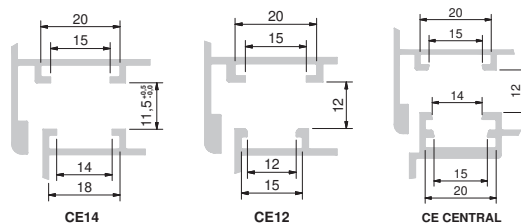

OBG60+ (LOGIC)

REF.	DESIGNATION	UNITS	PACKING	PACK.GR.	OBSERVATIONS
	OBG60+ Tilt and turn Kit (6 Locking Points)	UN	1	-	
	OBG60K+ Tilt and turn Kit w/ Cremona w/ Key (6 Locking Points)	UN	1	-	<p>opening logic maneuver</p> <p>Standard EN 13126</p>

Accessories OBG60+ (LOGIC)

REF.	DESIGNATION	UNITS	PACKING	PACK.GR.	FINISHING	OBSERVATIONS
	CPEQML TBT Compass - Small Arm	UN	1	226	Zinc	(435-700)
	CGDEML TBT Compass - Big Arm	UN	1	329	Zinc	(563-1000)
	CSUPML Additional Arm	UN	1	243	Stainless Steel	1000<L<1700mm
	KITH/V 18220 H/V Additional Locking Set	UN	20	2814	Zinc	-
	PFSUP 18222 Additional Adjustable Locking Point Set	UN	50	2510	Zinc	-



Accessories OBG60+ (LOGIC)

	REF.	DESIGNATION	UNITS	PACKING	PACK.GR.	FINISHING	OBSERVATIONS
	OBG2	Passive Leaf Hinge Set	UN	5	2376	Powder Painting	With regulation
	MICROVEN	Microventilation Set	UN	20	1099	Zinc	With air intake regulation
	33051	Passive Leaf Bi-directional Locking Drive Set w/ Simple Zamak Terminal	UN	10	3009	Zinc	-
	FALAVML 18246	Passive Leaf Zamak Lock Set	UN	5	2086	Zinc	In Zamak EG14 Only
	FECRAMPA	Adjustable Hidden Lock Ramp	UN	50	1316	Zinc	-
	CAJUSTE 18221	Leaf Support	UN	50	503	Black Nylon	-
	F2FALUM+ 18245	Passive Leaf Aluminium Lock Set	UN	1	148	Anodized 04	In Aluminium
	L150	Regulable Limiting Arm w/ 150mm	UN	40	3378	Powder Painting	With pressure regulation. Stainless Steel Bolt
	L220	Regulable Limiting Arm w/ 220mm	UN	60	5538	Powder Painting	With pressure regulation. Stainless Steel Bolt
	L300	Regulable Limiting Arm w/ 300mm	UN	40	4162	Powder Painting	With pressure regulation. Stainless Steel Bolt



GLOBAL PLUS TILT AND TURN

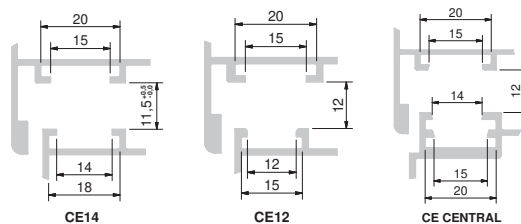

OBG60+S (LOGIC)

REF.	DESIGNATION	UNITS	PACKING	PACK.GR.	OBSERVATIONS
	OBG60+SD Tilt before turn Kit (Right) w/ Security Key Cremona	UN	1	-	 Only tilts when locked Opens only unlocked Standard EN 13126
	OBG60+SE Tilt before turn Kit (Left) w/ Security Key Cremona	UN	1	-	

Accessories OBG60+S (LOGIC)

REF.	DESIGNATION	UNITS	PACKING	PACK.GR.	FINISHING	OBSERVATIONS
	CPEQML TBT Compass - Small Arm	UN	1	226	Zinc	(435-700)
	CGDEML TBT Compass - Big Arm	UN	1	329	Zinc	(563-1000)
	CSUPML Additional Arm	UN	1	243	Stainless Steel	1000<L<1700mm
	KITHV 18220 H/V Additional Locking Set	UN	20	2814	Zinc	-
	PFSUP 18222 Additional Adjustable Locking Point Set	UN	50	2510	Zinc	-
	OBG2 Passive Leaf Hinge Set	UN	5	2376	Powder Painting	With regulation



Accessories OBG60+S (LOGIC)



REF.	DESIGNATION	UNITS	PACKING	PACK.GR.	FINISHING	OBSERVATIONS	
	MICROVEN	Microvention Set	UN	20	1099	Zinc	With air intake regulation
	33051	Passive Leaf Bi-directional Locking Drive Set w/ Simple Zamak Terminal	UN	10	3009	Zinc	-
	FALAVML 18246	Passive Leaf Zamak Lock Set	UN	5	2086	Zinc	In Zamak EG14 Only
	FECRAMPA	Adjustable Hidden Lock Ramp	UN	50	1316	Zinc	-
	CAJUSTE 18221	Leaf Support	UN	50	503	Black Nylon	-
	F2FALUM+ 18245	Passive Leaf Aluminium Lock Set	UN	1	148	Anodized 04	In Aluminium
	L150	Regulable Limiting Arm w/ 150mm	UN	40	3378	Powder Painting	With pressure regulation. Stainless Steel Bolt
	L220	Regulable Limiting Arm w/ 220mm	UN	60	5538	Powder Painting	With pressure regulation. Stainless Steel Bolt
	L300	Regulable Limiting Arm w/ 300mm	UN	40	4162	Powder Painting	With pressure regulation. Stainless Steel Bolt

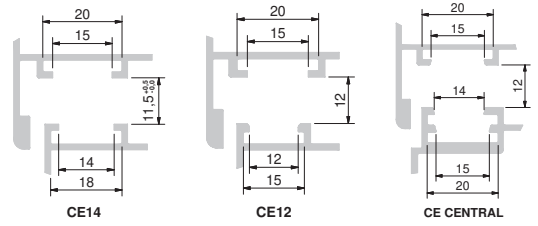

GLOBAL PLUS TILT AND TURN

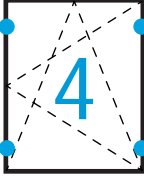
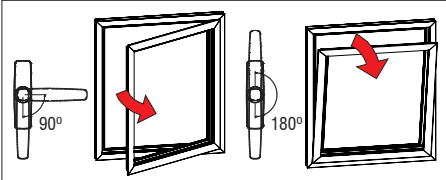

OBG60G

REF.	DESIGNATION	UNITS	PACKING	PACK.GR.	OBSERVATIONS
OBG60G	Tilt and turn Basic Kit f/ Gearbox (4 Locking Points)	UN	1	-	 <p>Gearbox Mechanism sold separately.</p>   <p>normal opening</p>  <p>Standard EN 13126</p>

Accessories OBG60G

REF.	DESIGNATION	UNITS	PACKING	PACK.GR.	FINISHING	OBSERVATIONS
9322	Gearbox Mechanism (7mm Axis)	UN	10	-	Zinc	-
9323	Gearbox Mechanism (11mm Axis)	UN	10	-	Zinc	-
9324	Gearbox Mechanism (13,5mm Axis)	UN	10	-	Zinc	-
CMIC	Compass - Micro Arm	UN	1	204	Zinc	(340-430)
CMINI	Compass - Mini Arm	UN	1	192	Zinc	(370-550)
CPEQ	Compass - Small Arm	UN	1	225	Zinc	(435-700)
CGDE	Compass - Big Arm	UN	1	316	Zinc	(563-1000)
CSUP	Additional Arm	UN	1	243	Stainless Steel	1000<L<1700mm
KITH/V 18220	H/V Additional Locking Set	UN	20	2814	Zinc	-



Accessories OBG60G



	REF.	DESIGNATION	UNITS	PACKING	PACK.GR.	FINISHING	OBSERVATIONS
	PFSUP 18222	Additional Adjustable Locking Point Set	UN	50	2510	Zinc	-
	OBG2	Passive Leaf Hinge Set	UN	5	2376	Powder Painting	With regulation
	MICROVEN	Microventilation Set	UN	20	1099	Zinc	With air intake regulation
	33051	Passive Leaf Bi-directional Locking Drive Set w/ Simple Zamak Terminal	UN	10	3009	Zinc	-
	FALAV 18219	Passive Leaf Zamak Lock Set	UN	5	2115	Zinc	In Zamak EG14 Only
	FECRAMPA	Adjustable Hidden Lock Ramp	UN	50	1316	Zinc	-
	CAJUSTE 18221	Leaf Support	UN	50	503	Black Nylon	-
	F2FALUM 9310	Passive Leaf Aluminium Lock Set	UN	1	93	Anodized 04	In Aluminium
	L150	Regulable Limiting Arm w/ 150mm	UN	40	3378	Powder Painting	With pressure regulation. Stainless Steel Bolt
	L220	Regulable Limiting Arm w/ 220mm	UN	60	5538	Powder Painting	With pressure regulation. Stainless Steel Bolt
	L300	Regulable Limiting Arm w/ 300mm	UN	40	4162	Powder Painting	With pressure regulation. Stainless Steel Bolt

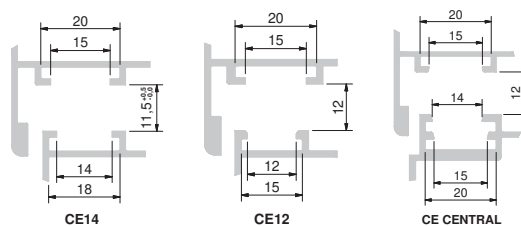

GLOBAL PLUS TILT AND TURN

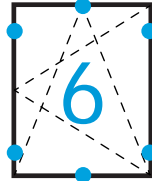
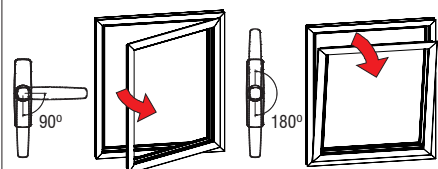

OBG60G+ (PLUS)

REF.	DESIGNATION	UNITS	PACKING	PACK.GR.	OBSERVATIONS
OBG60G+	Tilt and turn Kit f/ Gearbox (6 Locking Points)	UN	1	-	 <p>Gearbox Mechanism sold separately.</p>   <p>normal opening</p>  <p>Standard EN 13126</p>

Accessories OBG60G+ (PLUS)

REF.	DESIGNATION	UNITS	PACKING	PACK.GR.	FINISHING	OBSERVATIONS
9322	Gearbox Mechanism (7mm Axis)	UN	10	-	Zinc	-
9323	Gearbox Mechanism (11mm Axis)	UN	10	-	Zinc	-
9324	Gearbox Mechanism (13,5mm Axis)	UN	10	-	Zinc	-
CMIC	Compass - Micro Arm	UN	1	204	Zinc	(340-430)
CMINI	Compass - Mini Arm	UN	1	192	Zinc	(370-550)
CPEQ	Compass - Small Arm	UN	1	225	Zinc	(435-700)
CGDE	Compass - Big Arm	UN	1	316	Zinc	(563-1000)
CSUP	Additional Arm	UN	1	243	Stainless Steel	1000<L<1700mm
KITH/V 18220	H/V Additional Locking Set	UN	20	2814	Zinc	-



Accessories OBG60G+ (PLUS)



	REF.	DESIGNATION	UNITS	PACKING	PACK.GR.	FINISHING	OBSERVATIONS
	PFSUP 18222	Additional Adjustable Locking Point Set	UN	50	2510	Zinc	-
	OBG2	Passive Leaf Hinge Set	UN	5	2376	Powder Painting	With regulation
	MICROVEN	Microventilation Set	UN	20	1099	Zinc	With air intake regulation
	33051	Passive Leaf Bi-directional Locking Drive Set w/ Simple Zamak Terminal	UN	10	3009	Zinc	-
	FALAVML 18246	Passive Leaf Zamak Lock Set	UN	5	2086	Zinc	In Zamak EG14 Only
	FECRAMPA	Adjustable Hidden Lock Ramp	UN	50	1316	Zinc	-
	CAJUSTE 18221	Leaf Support	UN	50	503	Black Nylon	-
	F2FALUM+ 18245	Passive Leaf Aluminium Lock Set	UN	1	148	Anodized 04	In Aluminium
	L150	Regulable Limiting Arm w/ 150mm	UN	40	3378	Powder Painting	With pressure regulation. Stainless Steel Bolt
	L220	Regulable Limiting Arm w/ 220mm	UN	60	5538	Powder Painting	With pressure regulation. Stainless Steel Bolt
	L300	Regulable Limiting Arm w/ 300mm	UN	40	4162	Powder Painting	With pressure regulation. Stainless Steel Bolt

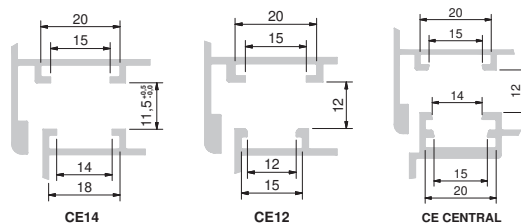

GLOBAL PLUS TILT AND TURN

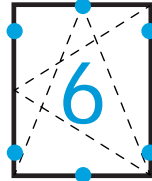
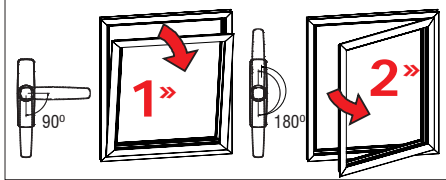

OBG60G+ (LOGIC)

REF.	DESIGNATION	UNITS	PACKING	PACK.GR.	OBSERVATIONS
OBG60G+	Tilt and turn Kit f/ Gearbox (6 Locking Points)	UN	1	-	 <p>Gearbox Mechanism sold separately.</p>   <p>normal opening</p>  <p>Standard EN 13126</p>

Accessories OBG60+S (LOGIC)

REF.	DESIGNATION	UNITS	PACKING	PACK.GR.	FINISHING	OBSERVATIONS
9322	Gearbox Mechanism (7mm Axis)	UN	10	-	Zinc	-
9323	Gearbox Mechanism (11mm Axis)	UN	10	-	Zinc	-
9324	Gearbox Mechanism (13,5mm Axis)	UN	10	-	Zinc	-
CPEQML	TBT Compass - Small Arm	UN	1	226	Zinc	(435-700)
CGDEML	TBT Compass - Big Arm	UN	1	329	Zinc	(563-1000)
CSUPML	Additional Arm	UN	1	243	Stainless Steel	1000<L<1700mm
KITH/V 18220	H/V Additional Locking Set	UN	20	2814	Zinc	-
PFSUP 18222	Additional Adjustable Locking Point Set	UN	50	2510	Zinc	-



Accessories OBG60+S (LOGIC)





	REF.	DESIGNATION	UNITS	PACKING	PACK.GR.	FINISHING	OBSERVATIONS
	OBG2	Passive Leaf Hinge Set	UN	5	2376	Powder Painting	With regulation
	MICROVEN	Microventilation Set	UN	20	1099	Zinc	With air intake regulation
	33051	Passive Leaf Bi-directional Locking Drive Set w/ Simple Zamak Terminal	UN	10	3009	Zinc	-
	FALAVML 18246	Passive Leaf Zamak Lock Set	UN	5	2086	Zinc	In Zamak EG14 Only
	FECRAMPA	Adjustable Hidden Lock Ramp	UN	50	1316	Zinc	-
	CAJUSTE 18221	Leaf Support	UN	50	503	Black Nylon	-
	F2FALUM+ 18245	Passive Leaf Aluminium Lock Set	UN	1	148	Anodized 04	In Aluminium
	L150	Regulable Limiting Arm w/ 150mm	UN	40	3378	Powder Painting	With pressure regulation. Stainless Steel Bolt
	L220	Regulable Limiting Arm w/ 220mm	UN	60	5538	Powder Painting	With pressure regulation. Stainless Steel Bolt
	L300	Regulable Limiting Arm w/ 300mm	UN	40	4162	Powder Painting	With pressure regulation. Stainless Steel Bolt

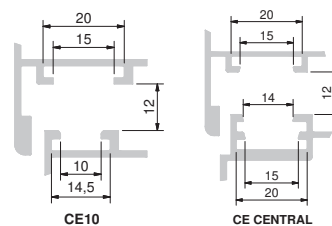

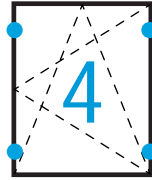

GLOBAL PLUS TILT AND TURN

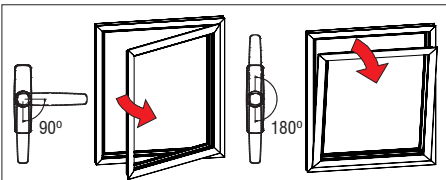

OBG60C10

REF.	DESIGNATION	UNITS	PACKING	PACK.GR.	OBSERVATIONS
	OBG60C10 Tilt and turn Basic Kit (4 Locking Points)	UN	1	-	
	OBG60KC10 Tilt and turn Basic Kit w/ Cremona w/ Key (4 Locking Points)	UN	1	-	 <p>normal opening</p>  <p>Standard EN 13126</p>

Accessories OBG6C10

REF.	DESIGNATION	UNITS	PACKING	PACK.GR.	FINISHING	OBSERVATIONS
	CMIC Compass - Micro Arm	UN	1	204	Zinc	(340-430)
	CMINI Compass - Mini Arm	UN	1	192	Zinc	(370-550)
	CPEQ Compass - Small Arm	UN	1	225	Zinc	(435-700)
	CGDE Compass - Big Arm	UN	1	316	Zinc	(563-1000)
	CSUP Additional Arm	UN	1	243	Stainless Steel	1000<L<1700mm
	KITH/V 18286 H/V Additional Locking Set	UN	20	2814	Zinc	-



Accessories OBG6C10

	REF.	DESIGNATION	UNITS	PACKING	PACK.GR.	FINISHING	OBSERVATIONS
	PFSUP 18255	Additional Locking Point Set	UN	50	2488	Zinc	-
	OBG2	Passive Leaf Hinge Set	UN	5	2376	Powder Painting	With regulation
	33051	Passive Leaf Bi-directional Locking Drive Set w/ Simple Zamak Terminal	UN	10	3009	Zinc	-
	CAJUSTE 18221	Leaf Support	UN	50	503	Black Nylon	-
	F2FALUM 9310	Passive Leaf Aluminium Lock Set	UN	1	93	Anodized 04	In Aluminium
	L150	Regulable Limiting Arm w/ 150mm	UN	40	3378	Powder Painting	With pressure regulation. Stainless Steel Bolt
	L220	Regulable Limiting Arm w/ 220mm	UN	60	5538	Powder Painting	With pressure regulation. Stainless Steel Bolt
	L300	Regulable Limiting Arm w/ 300mm	UN	40	4162	Powder Painting	With pressure regulation. Stainless Steel Bolt



GLOBAL PLUS TILT AND TURN

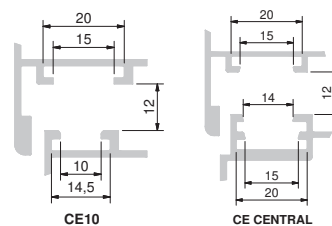

OBG60+SC10 (LOGIC)





REF.	DESIGNATION	UNITS	PACKING	PACK.GR.	OBSERVATIONS
	OBG60+SDC10 Tilt before turn Kit C10 (Right) w/ Security Key Cremona	UN	1	-	
	OBG60+SEC10 Tilt before turn Kit C10 (Left) w/ Security Key Cremona	UN	1	-	<p>Only tilts when locked</p> <p>Opens only unlocked</p> <p>130 kg</p> <p>Standard EN 13126</p>

Accessories OBG60+SC10 (LOGIC)

REF.	DESIGNATION	UNITS	PACKING	PACK.GR.	FINISHING	OBSERVATIONS
	CPEQML TBT Compass - Small Arm	UN	1	226	Zinc	(435-700)
	CGDEML TBT Compass - Big Arm	UN	1	329	Zinc	(563-1000)
	CSUPML Additional Arm	UN	1	243	Stainless Steel	1000<L<1700mm
	KITH/V 18286 H/V Additional Locking Set	UN	20	2814	Zinc	-
	PFSUP 18255 Additional Locking Point Set	UN	50	2488	Zinc	-











Accessories OBG60+SC10 (LOGIC)

	REF.	DESIGNATION	UNITS	PACKING	PACK.GR.	FINISHING	OBSERVATIONS
	OBG2	Passive Leaf Hinge Set	UN	5	2376	Powder Painting	With regulation
	CAJUSTE 18221	Leaf Support	UN	50	503	Black Nylon	-
	F2FALUM+ 18245	Passive Leaf Aluminium Lock Set	UN	1	148	Anodized 04	In Aluminium
	L150	Regulable Limiting Arm w/ 150mm	UN	40	3378	Powder Painting	With pressure regulation. Stainless Steel Bolt
	L220	Regulable Limiting Arm w/ 220mm	UN	60	5538	Powder Painting	With pressure regulation. Stainless Steel Bolt
	L300	Regulable Limiting Arm w/ 300mm	UN	40	4162	Powder Painting	With pressure regulation. Stainless Steel Bolt



GLOBAL PLUS LINE

REF.	DESIGNATION	UNITS	PACKING	PACK.GR.	FINISHING	OBSERVATIONS
 6020	Cremona f/ Euro Groove (Euro Fixation)	UN	12	.	Powder Painting	Also available w/ M and L nails
 6020K	Cremona f/ Euro Groove w/ Key (Euro Fixation)	UN	10	.	Powder Painting	Also available w/ M and L nails  Equal keys
 6045S	Cremona f/ Tilt-turn Euro Groove - 12mm Nail (Euro Fixation)	UN	10	.	Powder Painting	-
 6045SK	Cremona f/ Tilt-turn Euro Groove w/ Key - 12mm Nail (Euro Fixation)	UN	10	.	Powder Painting	 Equal keys
 6008	Handle 3 Positions (Square of 7 x 32mm)	UN	10	.	Powder Painting	Also available w/ Square of 7x23mm and 7x60mm
 6008DO	Double Handle 3 Positions (Square of 7 x 33 a 45mm)	PAIRS	6	.	Powder Painting	-
 6015	Double Spring-loaded Handle f/ Doors (Square of 8 x 100mm)	PAIRS	12	.	Powder Painting	Also available w/ Square of 8x140mm
 33069	Lock Shield for Cylinder	UN	25	.	Powder Painting	-

NEW

NOTE: Nails M (27mm) and L (37mm) +0,15€.
 Square of 7x60mm +0,15€.
 Square of 8x140 +0,15€.
 Included screws except where indicated.

GLOBAL PLUS
LINE



GLOBAL PLUS





GLOBAL TILT AND TURN

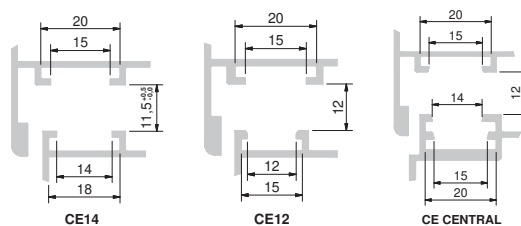

OBG6

REF.	DESIGNATION	UNITS	PACKING	PACK.GR.	OBSERVATIONS
	OBG6 Tilt and turn Basic Kit (4 Locking Points)	UN	1	1092	
	OBG6K Tilt and turn Basic Kit w/ Cremona w/ Key (4 Locking Points)	UN	1	1125	
	OBG6P Tilt and turn Basic Kit w/ Cremona w/o Handle (4 Locking Points)	UN	1	1030	 Standard EN 13126 Handle for OBG6P - 47P (Chapter Global Line - P F2)

Accessories OBG6

REF.	DESIGNATION	UNITS	PACKING	PACK.GR.	FINISHING	OBSERVATIONS
	CMIC Compass - Micro Arm	UN	1	204	Zinc	(340-430)
	CMINI Compass - Mini Arm	UN	1	192	Zinc	(370-550)
	CPEQ Compass - Small Arm	UN	1	225	Zinc	(435-700)
	CGDE Compass - Big Arm	UN	1	316	Zinc	(563-1000)
	CSUP Additional Arm	UN	1	243	Stainless Steel	1000<L<1700mm
	KITH/V 18220 H/V Additional Locking Set	UN	20	2814	Zinc	-
	PFSUP 18222 Additional Adjustable Locking Point Set	UN	50	2510	Zinc	-



Accessories OBG6

	REF.	DESIGNATION	UNITS	PACKING	PACK.GR.	FINISHING	OBSERVATIONS
	OBG2	Passive Leaf Hinge Set	UN	5	2376	Powder Painting	With regulation
	MICROVEN	Microventilation Set	UN	20	1099	Zinc	With air intake regulation
	33051	Passive Leaf Bi-directional Locking Drive Set w/ Simple Zamak Terminal	UN	10	3009	Zinc	-
	FALAV 18219	Passive Leaf Zamak Lock Set	UN	5	2115	Zinc	In Zamak EG14 Only
	FECRAMPA	Adjustable Hidden Lock Ramp	UN	50	1316	Zinc	-
	CAJUSTE 18221	Leaf Support	UN	50	503	Black Nylon	-
	F2FALUM 9310	Passive Leaf Aluminium Lock Set	UN	1	93	Anodized 04	In Aluminium
	L150	Regulable Limiting Arm w/ 150mm	UN	40	3378	Powder Painting	With pressure regulation. Stainless Steel Bolt
	L220	Regulable Limiting Arm w/ 220mm	UN	60	5538	Powder Painting	With pressure regulation. Stainless Steel Bolt
	L300	Regulable Limiting Arm w/ 300mm	UN	40	4162	Powder Painting	With pressure regulation. Stainless Steel Bolt



GLOBAL TILT AND TURN

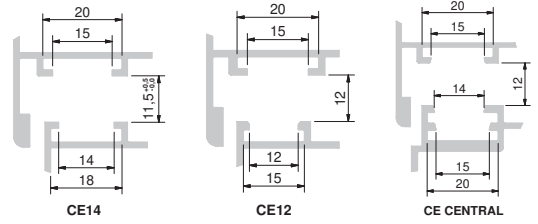

OBG6+ (PLUS)









REF.	DESIGNATION	UNITS	PACKING	PACK.GR.	OBSERVATIONS
	OBG6+ Tilt and turn Kit (6 Locking Points)	UN	1	1234	
	OBG6K+ Tilt and turn Kit w/ Cremona w/ Key (6 Locking Points)	UN	1	1267	
	OBG+P Tilt and turn Kit w/ Cremona w/o Handle (6 Locking Points)	UN	1	1172	 Standard EN 13126 Handle for OBG+P - 47P (Chapter Global Line - P.F2)

Accessories OBG6+ (PLUS)

REF.	DESIGNATION	UNITS	PACKING	PACK.GR.	FINISHING	OBSERVATIONS
	CMC Compass - Micro Arm	UN	1	204	Zinc	(340-430)
	CMINI Compass - Mini Arm	UN	1	192	Zinc	(370-550)
	CPEQ Compass - Small Arm	UN	1	225	Zinc	(435-700)
	CGDE Compass - Big Arm	UN	1	316	Zinc	(563-1000)
	CSUP Additional Arm	UN	1	243	Stainless Steel	1000<L<1700mm
	KITH/V 18220 H/V Additional Locking Set	UN	20	2814	Zinc	-
	PFSUP 18222 Additional Adjustable Locking Point Set	UN	50	2510	Zinc	-



Accessories OBG6+ (PLUS)





REF.	DESIGNATION	UNITS	PACKING	PACK.GR.	FINISHING	OBSERVATIONS	
	OBG2	Passive Leaf Hinge Set	UN	5	2376	Powder Painting	With regulation
	MICROVEN	Microventilation Set	UN	20	1099	Zinc	With air intake regulation
	33051	Passive Leaf Bi-directional Locking Drive Set w/ Simple Zamak Terminal	UN	10	3009	Zinc	-
	FALAVML 18246	Passive Leaf Zamak Lock Set	UN	5	2086	Zinc	In Zamak EG14 Only
	FECRAMPA	Adjustable Hidden Lock Ramp	UN	50	1316	Zinc	-
	CAJUSTE 18221	Leaf Support	UN	50	503	Black Nylon	-
	F2FALUM+ 18245	Passive Leaf Aluminium Lock Set	UN	1	148	Anodized 04	In Aluminium
	L150	Regulable Limiting Arm w/ 150mm	UN	40	3378	Powder Painting	With pressure regulation. Stainless Steel Bolt
	L220	Regulable Limiting Arm w/ 220mm	UN	60	5538	Powder Painting	With pressure regulation. Stainless Steel Bolt
	L300	Regulable Limiting Arm w/ 300mm	UN	40	4162	Powder Painting	With pressure regulation. Stainless Steel Bolt

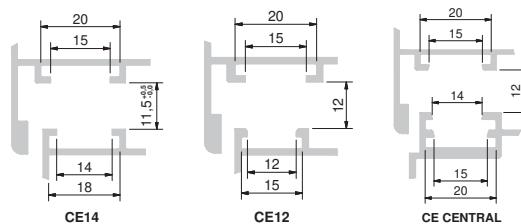



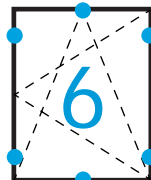

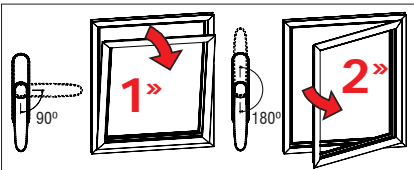
GLOBAL TILT AND TURN



OBG6+ (LOGIC)



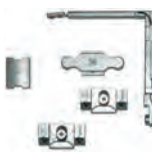

REF.	DESIGNATION	UNITS	PACKING	PACK.GR.	OBSERVATIONS
	OBG6+ Tilt and turn Kit (6 Locking Points)	UN	1	1234	
	OBG6K+ Tilt and turn Kit w/ Cremona w/o Key (6 Locking Points)	UN	1	1267	 opening logic maneuver
	OBG+P Tilt and turn Kit w/ Cremona w/o Handle (6 Locking Points)	UN	1	1172	 Standard EN 13126 Handle for OBG+P - 47P (Chapter Global Line - P. F2)

Accessories OBG6+ (LOGIC)

REF.	DESIGNATION	UNITS	PACKING	PACK.GR.	FINISHING	OBSERVATIONS
	CPEQML TBT Compass - Small Arm	UN	1	226	Zinc	(435-700)
	CGDEML TBT Compass - Big Arm	UN	1	329	Zinc	(563-1000)
	CSUPML Additional Arm	UN	1	243	Stainless Steel	1000<L<1700mm
	KITH/V 18220 H/V Additional Locking Set	UN	20	2814	Zinc	-
	PFSUP 18222 Additional Adjustable Locking Point Set	UN	50	2510	Zinc	-



Accessories OBG6+ (LOGIC)



	REF.	DESIGNATION	UNITS	PACKING	PACK.GR.	FINISHING	OBSERVATIONS
	OBG2	Passive Leaf Hinge Set	UN	5	2376	Powder Painting	With regulation
	MICROVEN	Microventilation Set	UN	20	1099	Zinc	With air intake regulation
	33051	Passive Leaf Bi-directional Locking Drive Set w/ Simple Zamak Terminal	UN	10	3009	Zinc	-
	FALAVML 18246	Passive Leaf Zamak Lock Set	UN	5	2086	Zinc	In Zamak EG14 Only
	FECRAMPA	Adjustable Hidden Lock Ramp	UN	50	1316	Zinc	-
	CAJUSTE 18221	Leaf Support	UN	50	503	Black Nylon	-
	F2FALUM+ 18245	Passive Leaf Aluminium Lock Set	UN	1	148	Anodized 04	In Aluminium
	L150	Regulable Limiting Arm w/ 150mm	UN	40	3378	Powder Painting	With pressure regulation. Stainless Steel Bolt
	L220	Regulable Limiting Arm w/ 220mm	UN	60	5538	Powder Painting	With pressure regulation. Stainless Steel Bolt
	L300	Regulable Limiting Arm w/ 300mm	UN	40	4162	Powder Painting	With pressure regulation. Stainless Steel Bolt

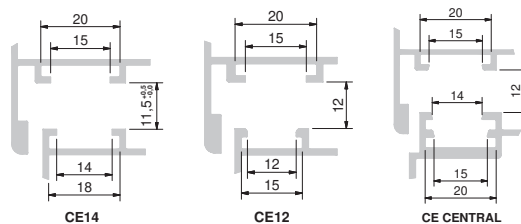

GLOBAL TILT AND TURN

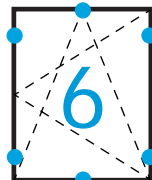
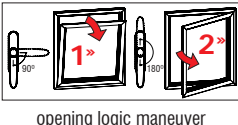

OBG6+S (LOGIC)

REF.	DESIGNATION	UNITS	PACKING	PACK.GR.	OBSERVATIONS
	OBG+SD Tilt before turn Kit (Right) w/ Security Key Cremona	UN	1	1252	  Only tilts when locked Opens only unlocked 
	OBG+SE Tilt before turn Kit (Left) w/ Security Key Cremona	UN	1	1252	

Accessories OBG6+S (LOGIC)

REF.	DESIGNATION	UNITS	PACKING	PACK.GR.	FINISHING	OBSERVATIONS
	CPEQML TBT Compass - Small Arm	UN	1	226	Zinc	(435-700)
	CGDEML TBT Compass - Big Arm	UN	1	329	Zinc	(563-1000)
	CSUPML Additional Arm	UN	1	243	Stainless Steel	1000<L<1700mm
	KITH/V 18220 H/V Additional Locking Set	UN	20	2814	Zinc	-
	PFSUP 18222 Additional Adjustable Locking Point Set	UN	50	2510	Zinc	-
	OBG2 Passive Leaf Hinge Set	UN	5	2376	Powder Painting	With regulation



Accessories OBG6+S (LOGIC)





REF.	DESIGNATION	UNITS	PACKING	PACK.GR.	FINISHING	OBSERVATIONS	
	MICROVEN	Microvention Set	UN	20	1099	Zinc	With air intake regulation
	33051	Passive Leaf Bi-directional Locking Drive Set w/ Simple Zamak Terminal	UN	10	3009	Zinc	-
	FALAVML 18246	Passive Leaf Zamak Lock Set	UN	5	2086	Zinc	In Zamak EG14 Only
	FECRAMPA	Adjustable Hidden Lock Ramp	UN	50	1316	Zinc	-
	CAJUSTE 18221	Leaf Support	UN	50	503	Black Nylon	-
	F2FALUM+ 18245	Passive Leaf Aluminium Lock Set	UN	1	148	Anodized 04	In Aluminium
	L150	Regulable Limiting Arm w/ 150mm	UN	40	3378	Powder Painting	With pressure regulation. Stainless Steel Bolt
	L220	Regulable Limiting Arm w/ 220mm	UN	60	5538	Powder Painting	With pressure regulation. Stainless Steel Bolt
	L300	Regulable Limiting Arm w/ 300mm	UN	40	4162	Powder Painting	With pressure regulation. Stainless Steel Bolt

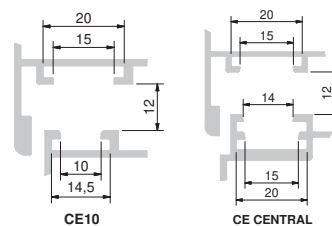

GLOBAL TILT AND TURN

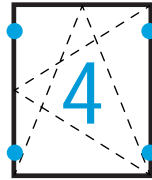

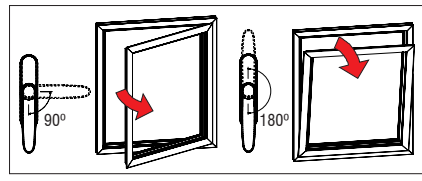
OBG6C10







REF.	DESIGNATION	UNITS	PACKING	PACK.GR.	OBSERVATIONS
	OBG6C10 Tilt and turn Basic Kit (4 Locking Points)	UN	1	1092	
	OBG6KC10 Tilt and turn Basic Kit w/ Cremona w/ Key (4 Locking Points)	UN	1	1125	 normal opening
	OBG6PC10 Tilt and turn Basic Kit w/ Cremona w/o Handle (4 Locking Points)	UN	1	1030	 Standard EN 13126 Handle for OBG6PC10 - 47P (Chapter Global Line - P.F2)

Accessories OBG6C10

REF.	DESIGNATION	UNITS	PACKING	PACK.GR.	FINISHING	OBSERVATIONS
	CMIC Compass - Micro Arm	UN	1	204	Zinc	(340-430)
	CMINI Compass - Mini Arm	UN	1	192	Zinc	(370-550)
	CPEQ Compass - Small Arm	UN	1	225	Zinc	(435-700)
	CGDE Compass - Big Arm	UN	1	316	Zinc	(563-1000)
	CSUP Additional Arm	UN	1	243	Stainless Steel	1000<L<1700mm
	KITH/V 18286 H/V Additional Locking Set	UN	20	2814	Zinc	-



Accessories OBG6C10



	REF.	DESIGNATION	UNITS	PACKING	PACK.GR.	FINISHING	OBSERVATIONS
	PFSUP 18255	Additional Locking Point Set	UN	50	2488	Zinc	-
	OBG2	Passive Leaf Hinge Set	UN	5	2376	Powder Painting	With regulation
	33051	Passive Leaf Bi-directional Locking Drive Set w/ Simple Zamak Terminal	UN	10	3009	Zinc	-
	CAJUSTE 18221	Leaf Support	UN	50	503	Black Nylon	-
	F2FALUM 9310	Passive Leaf Aluminium Lock Set	UN	1	93	Anodized 04	In Aluminium
	L150	Regulable Limiting Arm w/ 150mm	UN	40	3378	Powder Painting	With pressure regulation. Stainless Steel Bolt
	L220	Regulable Limiting Arm w/ 220mm	UN	60	5538	Powder Painting	With pressure regulation. Stainless Steel Bolt
	L300	Regulable Limiting Arm w/ 300mm	UN	40	4162	Powder Painting	With pressure regulation. Stainless Steel Bolt

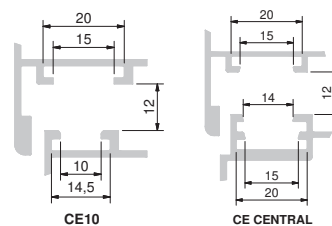

GLOBAL TILT AND TURN

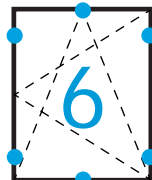
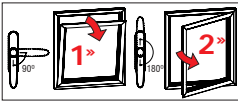

OBG6+SC10 (LOGIC)



REF.	DESIGNATION	UNITS	PACKING	PACK.GR.	OBSERVATIONS
	OBG+SDC10 Tilt before turn Kit C10 (Right) w/ Security Key Cremona	UN	1	1252	  Only tilts when locked Opens only unlocked 
	OBG+SEC10 Tilt before turn Kit C10 (Left) w/ Security Key Cremona	UN	1	1252	

Accessories OBG6+SC10 (LOGIC)

REF.	DESIGNATION	UNITS	PACKING	PACK.GR.	FINISHING	OBSERVATIONS
	CPEQML TBT Compass - Small Arm	UN	1	226	Zinc	(435-700)
	CGDEML TBT Compass - Big Arm	UN	1	329	Zinc	(563-1000)
	CSUPML Additional Arm	UN	1	243	Stainless Steel	1000<L<1700mm
	KITH/V 18286 H/V Additional Locking Set	UN	20	2814	Zinc	-
	PFSUP 18255 Additional Locking Point Set	UN	50	2488	Zinc	-
	OBG2 Passive Leaf Hinge Set	UN	5	2376	Powder Painting	With regulation



Accessories OBG6+SC10 (LOGIC)













	REF.	DESIGNATION	UNITS	PACKING	PACK.GR.	FINISHING	OBSERVATIONS
	CAJUSTE 18221	Leaf Support	UN	50	503	Black Nylon	-
	F2FALUM+ 18245	Passive Leaf Aluminium Lock Set	UN	1	148	Anodized 04	In Aluminium
	L150	Regulable Limiting Arm w/ 150mm	UN	40	3378	Powder Painting	With pressure regulation. Stainless Steel Bolt
	L220	Regulable Limiting Arm w/ 220mm	UN	60	5538	Powder Painting	With pressure regulation. Stainless Steel Bolt
	L300	Regulable Limiting Arm w/ 300mm	UN	40	4162	Powder Painting	With pressure regulation. Stainless Steel Bolt



REF.	DESIGNATION	UNITS	PACKING	PACK.GR.	FINISHING	OBSERVATIONS
620	Cremona for Euro Groove (Euro Fixation)	UN	12	4006	Powder Painting	Also available w/ M and L nails
620K	Cremona for Euro Groove w/ Key (Euro Fixation)	UN	10	3514	Powder Painting	Also available w/ M and L nails Equal keys
610	Cremona for Euro Groove (Frontal Fixation)	UN	12	3906	Powder Painting	Also available w/ M and L nails
610K	Cremona for Euro Groove w/ Key (Frontal Fixation)	UN	10	3429	Powder Painting	Also available w/ M and L nails Equal keys
624	Cremona w/ Detachable Cover (Frontal Fixation)	UN	10	2880	Powder Painting	Also available w/ M and L nails
621	Slim Cremona for Euro Groove (Euro Fixation)	UN	10	3319	Powder Painting	Disponível unha L (27,5mm)
611	Slim Cremona for Euro Groove (Frontal Fixation)	UN	10	3162	Powder Painting	Disponível unha L (27,5mm)
633	Lower Cremona for Euro Groove (Euro Fixation)	UN	10	3664	Powder Painting	Disponível unhas L (27,5mm)
630	Lower Cremona for Euro Groove (Frontal Fixation)	UN	10	3518	Powder Painting	Disponível unhas L (27,5mm)
660	Cremona for Curtain Wall (Euro Fixation)	UN	12	4441	Powder Painting	Also available w/ M and L nails
650	Cremona for Curtain Wall (Frontal Fixation)	UN	12	4334	Powder Painting	Also available w/ M and L nails
699	Set of Cremona for Tube (Frontal Fixation)	PAIRS	5	4145	Powder Painting	Also available w/ M and L nails

NOTE: Nails M (27mm) and L (37mm) +0,15€.
Included screws except where indicated.



	REF.	DESIGNATION	UNITS	PACKING	PACK.GR.	FINISHING	OBSERVATIONS
	699T1,0	Tube w/ 1,0 mt long for 699 Cremona	UN	5	2680	Powder Painting	-
	699T1,5	Tube w/ 1,5 mt long for 699 Cremona	UN	5	4020	Powder Painting	-
	699T2,0	Tube w/ 2,0 mt long for 699 Cremona	UN	5	5360	Powder Painting	-
	680	Security Cremona for Euro Groove w/o Handle (Euro Fixation)	UN	10	2626	Powder Painting	Also available w/ M and L nails
	670	Security Cremona for Euro Groove w/o Handle (Frontal Fixation)	UN	10	2546	Powder Painting	Also available w/ M and L nails
	47P	Handle for Cremona 670, 680	UN	10	741	Powder Painting	-
	645S	Cremona for Tilt-turn Euro Groove - 12mm Nail (Euro Fixation)	UN	10	3091	Powder Painting	-
	645SK	Cremona for Tilt-turn Euro Groove w/ Key - 12mm Nail (Euro Fixation)	UN	10	3314	Powder Painting	 Equal keys
	635S	Cremona for Tilt-turn Euro Groove - 12mm Nail (Frontal Fixation)	UN	10	3060	Powder Painting	-
	635SK	Cremona for Tilt-turn Euro Groove w/ Key - 12mm Nail (Frontal Fixation)	UN	10	3110	Powder Painting	 Equal keys
	625S	Cremona for Tilt-turn Euro Groove w/ Detachable Cover - 12mm Nail (Frontal Fixation)	UN	10	2685	Powder Painting	-
	685S	Security Cremona for Tilt-turn Euro Groove w/o Handle - 12mm Nail (Euro Fixation)	UN	10	2380	Powder Painting	-













NOTE: Nails M (27mm) and L (37mm) +0,15€.
Included screws except where indicated.

The total or partial reproduction of this list is forbidden without the authorization of ALUALPHA S. A.

Other colors see page 1











GLOBAL
LINE

	REF.	DESIGNATION	UNITS	PACKING	PACK.GR.	FINISHING	OBSERVATIONS
	675S	Security Cremona for Tilt-turn Euro Groove w/o Handle - 12mm Nail (Frontal Fixation)	UN	10	2350	Powder Painting	-
	608	Handle 3 Positions (Square of 7 x 32mm)	UN	10	2214	Powder Painting	Also available w/ Square of 7x23mm and 7x60mm
	609	Double Handle 3 Positions (Square of 7 x 33 a 45mm)	PAIRS	6	2298	Powder Painting	-
	628	Handle 3 Positions w/ Detachable Cover (Square of 7 x 25mm) (Frontal Fixation)	UN	10	2654	Powder Painting	-
	508G	Slim Handle 3 Positions (Square of 7 x 26mm)	UN	10	1890	Powder Painting	Also available w/ Square of 7x56mm
	508GD	Double Slim Handle 3 Positions (Square of 7 x 33 a 45mm)	PAIRS	6	2190	Powder Painting	Also available w/ Square of 7x22 to 34mm
	508CA	Wedge for 508 Handle 3 Positions	UN	10	445	Powder Painting	-
	615	Double Spring-loaded Handle for Doors (Square of 8 x 100mm)	PAIRS	12	5581	Powder Painting	Also available w/ Square of 8x140mm
	614	Double Spring-loaded Handle for Doors (Square of 8 x 100mm)	PAIRS	6	3252	Powder Painting	Also available w/ Square of 8x140mm
	605	Double Slim Spring-loaded Handle for Doors (Square of 8 x 100mm)	PAIRS	6	2371	Powder Painting	-
	605T	Double Slim Spring-loaded Handle w/ Plastic Caps for Doors (Square of 8 x 100mm)	PAIRS	6	2302	Powder Painting	-
	COMP-33042	Lock Shield for Cylinder	UN	25	726	Powder Painting	-
	616T	Double Long Mirror Handle for Doors for Cylinder (Square of 8 x 100mm)	PAIRS	6	3112	Powder Painting	Distance from the axle to the cylinder of 85mm

NOTE: Square of 7x56mm e 60mm e Square of 8x140mm +0,15€.
Included screws except where indicated.



REF.	DESIGNATION	UNITS	PACKING	PACK.GR.	FINISHING	OBSERVATIONS
	617T Double Long Mirror Handle for Doors for Cylinder (Square of 8x100mm)	PAIRS	6	3139	Powder Painting	Distance from the axle to the cylinder of 92mm
	607 Reversible Closing Handle	UN	10	2656	Powder Painting	-
	607T Reversible Closing Handle w/ Plastic Caps	UN	10	2589	Powder Painting	-
	606G Maxim-air Handle w/ Reversible Latch for GOLD Series	UN	20	3368	Powder Painting	-
	606S Maxim-air Handle w/ Reversible Latch for SUPREMA Series	UN	20	3368	Powder Painting	-
	642 Cremona for Outwards Opening (Frontal Fixation)	UN	8	2550	Powder Painting	-
	642K Cremona for Outwards Opening w/ Key (Frontal Fixation)	UN	8	2756	Powder Painting	 Equal keys
	627 Cremona for Outwards Opening w/ Detachable Cover (Frontal Fixation)	UN	8	2416	Powder Painting	-
	642P7 7mm Connection Pin for 642/627	UN	16	99	Stainless Steel	-
	642P10 10mm Connection Pin for 642/627	UN	16	110	Stainless Steel	-
	642P14 14mm Connection Pin for 642/627	UN	16	125	Stainless Steel	-
	642P16 16mm Connection Pin for 642/627	UN	16	132	Stainless Steel	-
	642P20 20mm Connection Pin for 642/627	UN	16	147	Stainless Steel	-
	642P26 26mm Connection Pin for 642/627	UN	16	169	Stainless Steel	-

NOTE: Included screws except where indicated.

The total or partial reproduction of this list is forbidden without the authorization of ALUALPHA S. A.

Other colors see page 1



HINGES

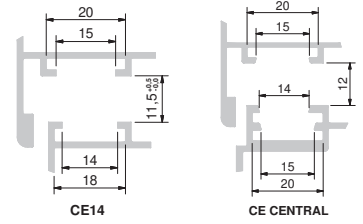

Frame groove 14

	REF.	DESIGNATION	UNITS	PACKING	PACK.GR.	FINISHING	OBSERVATIONS
	2XLD	Extra Large 3D Door Hinge	UN	4	1654	Powder Painting	
	2XL	Extra Large Door Hinge	UN	4	1625	Powder Painting	
	2XD	Extra 3D Door Hinge	UN	4	1335	Powder Painting	
	2X	Extra Door Hinge	UN	4	1311	Powder Painting	
	CE2F	Reversible Hinge EG Series - Adjustable Stainless Axle	UN	50	6023	Powder Painting	 Windows of 1/2 Leafs
	CE2N	Reversible Hinge EG Series - Stainless Axle	UN	50	5998	Powder Painting	 Windows of 1/2 Leafs
	CE3F	Reversible Hinge Third Leaf EG Series - Adjustable Stainless Axle	UN	50	6244	Powder Painting	 Windows of 3/4 Leafs
	CE3N	Reversible Hinge Third Leaf EG Series - Stainless Axle	UN	50	6244	Powder Painting	 Windows of 3/4 Leafs

NOTE: Included screws except where indicated.

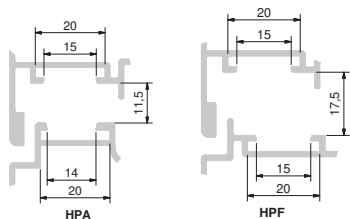

HINGES



Blinds

	REF.	DESIGNATION	UNITS	PACKING	PACK.GR.	FINISHING	OBSERVATIONS
	HPBA	Hinge for Exterior Opening - HP Series	UN	25	5098	Powder Painting	 Windows of 1/2 Leafs Ø8mm stainless steel axle.
	HPA	Hinge for Exterior Opening - HP Series	UN	50	6558	Powder Painting	 Windows of 1/2 Leafs Ø8mm stainless steel axle.
	HPBF	Hinge for Exterior Opening - HP Series	UN	25	5165	Powder Painting	 Windows of 3/4 Leafs Ø8mm stainless steel axle.
	HPF	Hinge for Exterior Opening - HP Series	UN	50	6665	Powder Painting	 Windows of 3/4 Leafs Ø8mm stainless steel axle.

Other series

	REF.	DESIGNATION	UNITS	PACKING	PACK.GR.	FINISHING	OBSERVATIONS
	GOLD2F	Reversible Hinge for GOLD Series	UN	50	5095	Powder Painting	
	SUP2F	Reversible Hinge for SUPREMA Series	UN	50	4720	Powder Painting	
	INOVA2F	Reversible Hinge for INOVA Series	UN	50	4950	Powder Painting	
	S38312F	Reversible Hinge for 38/31 Series	UN	50	4120	Powder Painting	 Windows of 1/2 Leafs
	S40202F	Reversible Hinge for 40/20 Series	UN	50	6500	Powder Painting	 Windows of 1/2 Leafs

NOTE: Included screws except where indicated.

The total or partial reproduction of this list is forbidden without the authorization of ALUALPHA S. A.

Other colors see page 1



HINGES

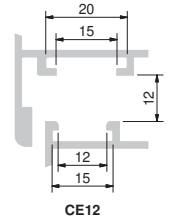

Frame groove 12

	REF.	DESIGNATION	UNITS	PACKING	PACK.GR.	FINISHING	OBSERVATIONS
	2XLD12	Extra Large 3D Door Hinge	UN	4	1311	Powder Painting	
	2XL12	Extra Large Door Hinge	UN	4	1311	Powder Painting	
	2XD12	Extra 3D Door Hinge	UN	4	1311	Powder Painting	
	2X12	Extra Door Hinge	UN	4	1311	Powder Painting	
	CE2G	Reversible Hinge EG Series - Adjustable Stainless Axle	UN	50	5998	Powder Painting	 Windows of 1/2 Leafs

NOTE: Included screws except where indicated.

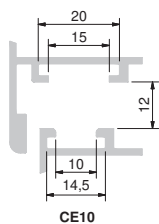

HINGES



Frame groove 10

	REF.	DESIGNATION	UNITS	PACKING	PACK.GR.	FINISHING	OBSERVATIONS
	2XLD10	Extra Large 3D Door Hinge	UN	4	1311	Powder Painting	
	2XL10	Extra Large Door Hinge	UN	4	1311	Powder Painting	
	2XD10	Extra 3D Door Hinge	UN	4	1311	Powder Painting	
	2X10	Extra Door Hinge	UN	4	1311	Powder Painting	
	CE2FC10	Reversible Hinge EG Series - Adjustable Stainless Axle	UN	50	6023	Powder Painting	 Windows of 1/2 Leafs.



KITS AND COMPLEMENTS

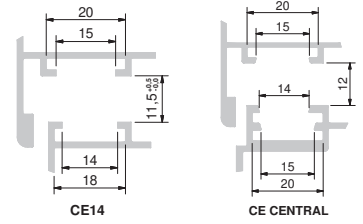

Frame groove 14







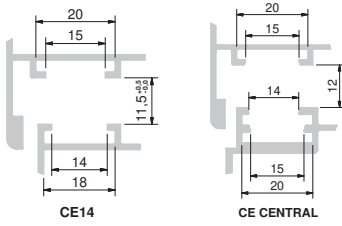

	REF.	DESIGNATION	UNITS	PACKING	PACK.GR.	FINISHING	OBSERVATIONS
	COMP-33039	Zamak Cremona Connection Kit w/ Terminal	CONJ	20	2553	Zinc	-
	COMP-33013	Nylon Cremona Connection Kit - Terminal w/ Tuning Tip and Locking Meeting	UN	30	2188	Black Nylon	-
	S2i	Nylon Cremona Connection Kit - Terminal and Locking Meeting	UN	20	1123	Black Nylon	-
	S2	Nylon Cremona Connection Kit - Terminal and Locking Meeting	UN	20	997	Black Nylon	-
	KIT-33034	Passive Leaf Kit w/ Zamak Terminal for EG Series (w/o Locking Meeting)	UN	50	2331	Zinc	-
	COMP-33040	Basic Kit for 1st and 2nd Leaf for EG Series - w/ Zamak Terminal (w/o Locking Meeting)	CONJ	20	3485	Zinc	-

NOTE: Included screws except where indicated.

KITS AND COMPLEMENTS



Frame groove 14

REF.	DESIGNATION	UNITS	PACKING	PACK.GR.	FINISHING	OBSERVATIONS	
	COMP-33001	Nylon Passive Leaf Kit for EG Series - w/ Zamak Locking Meeting	UN	50	2218	Black Nylon	-
	COMP-33003	Nylon Passive Leaf Kit for EG Series - w/ Zamak Low Locking Meeting	UN	50	2145	Black Nylon	-
	COMP-33015	Nylon Passive Leaf Kit for EG Series - Terminal w/ Tuning Tip and Zamak Locking Meeting	UN	50	2682	Black Nylon	-
	COMP-33041	Nylon Passive Leaf Kit for EG Series - Terminal w/ Tuning Tip and Zamak Low Locking Meeting	UN	50	2597	Black Nylon	-
	COMP-33024	Nylon Passive Leaf Kit - Terminal w/ Tuning Tip (w/o Locking Meeting)	UN	50	1788	Black Nylon	-
	KIT-33038	Nylon Passive Leaf Kit - Terminal w/ Stainless Steel Ø8 Tip for EG Series (w/o Locking Meeting)	UN	50	1934	Black Nylon	-
	COMP-33025	Nylon Kit for 1st and 2nd Leaf for EG Series - Terminal w/ Tuning Tip and Nylon Locking Meeting	UN	20	3023	Black Nylon	-
	COMP-33014	Nylon Kit for 1st and 2nd Leaf for EG Series - Terminal w/ Tuning Tip and Zamak Locking Meeting	UN	20	3057	Black Nylon	-

NOTE: Included screws except where indicated.

The total or partial reproduction of this list is forbidden without the authorization of ALUALPHA S. A.

Other colors see page 1



KITS AND COMPLEMENTS

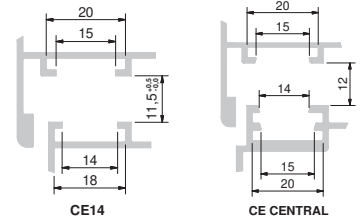

Frame groove 14







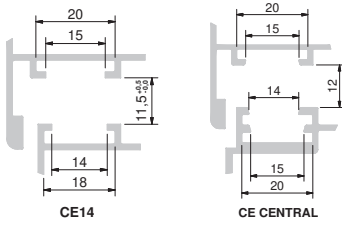



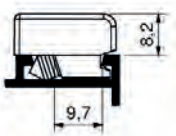

	REF.	DESIGNATION	UNITS	PACKING	PACK.GR.	FINISHING	OBSERVATIONS
	COMP-33043	Nylon Kit for 1st and 2nd Leaf for EG Series - Terminal w/ Tuning Tip (w/o Locking Meeting)	UN	20	2360	Black Nylon	-
	COMP-33008	Nylon Cremona Connection Kit	PAIRS	100	1566	Black Nylon	-
	KIT-33033	Zamak Cremona Connection Kit	PAIRS	20	1239	Zinc	-
	COMP-33005	Nylon Terminal	UN	50	435	Black Nylon	-
	COMP-33007	Nylon Terminal w/ Tuning Tip	UN	50	896	Black Nylon	-
	COMP-33006	Terminal w/ Stainless Steel Ø8 Tip	UN	50	1039	Black Nylon	-
	COMP-33017	Terminal w/ Stainless Steel Ø6 Tip	UN	50	941	Black Nylon	-
	COMP-33012	Zamak Terminal	UN	100	2789	Zinc	-
	KIT-33035	Zamak Door Lock for Passive Leaf	UN	10	1742	Zinc	-

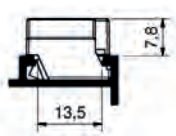
NOTE: Included screws except where indicated.

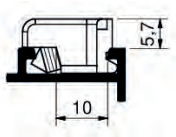
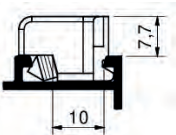
KITS AND COMPLEMENTS

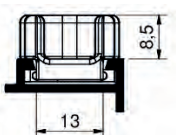

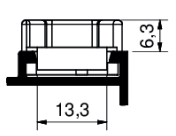
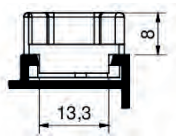
Frame groove 14

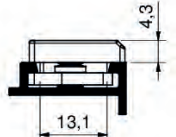
REF.	DESIGNATION	UNITS	PACKING	PACK.GR.	FINISHING	OBSERVATIONS	
	33055	Passive Leaf Bi-directional Locking Drive	UN	10	-	Stainless Steel	-
	COMP-33023	Double Zamak Locking Meeting	UN	50	1451	Zinc	
	OBG-18234	Zamak Double Locking Meeting w/ Regulation	UN	30	1820	Zinc	
	KIT-33004	Low Double Zamak Locking Meeting	UN	100	1663	Zinc	
	COMP-33022	Double Zamak Locking Meeting	UN	100	1872	Zinc	
	COMP-33009	Nylon Locking Meeting	UN	200	2368	Black Nylon	
	COMP-33018	Low Nylon Locking Meeting	UN	200	1573	Black Nylon	
	COMP-33019	Nylon Locking Meeting	UN	200	1796	Black Nylon	
	KIT-33020	Low Nylon Locking Meeting	UN	200	2700	Black Nylon	

NOTE: Included screws except where indicated.

The total or partial reproduction of this list is forbidden without the authorization of ALUALPHA S. A.

Other colors see page 1



KITS AND COMPLEMENTS

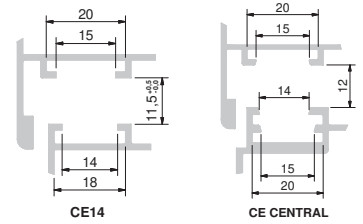

Frame groove 14





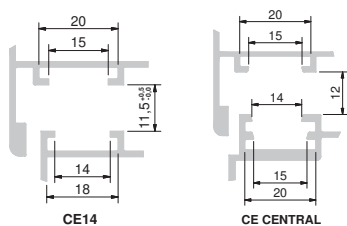

	REF.	DESIGNATION	UNITS	PACKING	PACK.GR.	FINISHING	OBSERVATIONS
	KIT-33021	Nylon Locking Meeting	UN	200	3543	Black Nylon	
	OBM-9312	Corner Transmission w/ Locking Point	UN	30	2915	Zinc	-
	OBM-9315	Corner Transmission	UN	30	2885	Zinc	-
	9319	Security Locking Point	UN	50	2240	Stainless Steel	
	9322	Gearbox Mechanism (7mm Axis)	UN	10	-	Zinc	-
	9323	Gearbox Mechanism (11mm Axis)	UN	10	-	Zinc	-
	9324	Gearbox Mechanism (13,5mm Axis)	UN	10	-	Zinc	-
	PFSUP 18222	Additional Adjustable Locking Point Set	UN	50	2510	Zinc	
	PTSUP 18252	Additional Locking Point	UN	100	2532	Zinc	-
	ENREG 18253	Adjustable Keeper	UN	100	2241	Zinc	
	OBM-9316	Additional Adjustable Locking Point	UN	100	800	Zinc	-
	OBG-70077	Transmission Cremona Cover	UN	30	1144	Zinc	-

NOTE: Included screws except where indicated.

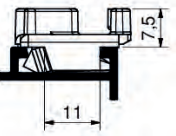
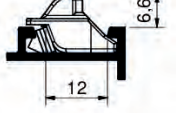
KITS AND COMPLEMENTS



Frame groove 14

REF.	DESIGNATION	UNITS	PACKING	PACK.GR.	FINISHING	OBSERVATIONS	
	CAJUSTE 18221	Leaf Support	UN	50	503	Black Nylon	
	MICROVEN	Microventilation Set	UN	20	1099	Zinc	
	33011 (2FAT)	Automatic Passive Leaf Stop	UN	50	1324	-	-
	FECRAMPA	Adjustable Hidden Lock Ramp	UN	50	1316	Zinc	
	COMP-33042	Lock Shield for Cylinder	UN	25	726	Powder Painting	-
	33050	Lock Shield for Cylinder	UN	25	1578	Powder Painting	-
	33069	Lock Shield for Cylinder	UN	25	-	Powder Painting	-
	KIT-33056	Fixation Kit f/ Double Handle (Profile 22 to 33mm)	UN	6	-	Zinc	-
	KIT-33057	Fixation Kit f/ Double Handle (Profile 33 to 45mm)	UN	6	-	Zinc	-
	DIV-70067	8x80mm Square	UN	6	233	Zinc	-
	DIV-70058	8x100mm Square	UN	6	292	Zinc	-
	DIV-70089	8x140mm Square	UN	6	-	Zinc	-
	DIV-70068	8x100mm Square Misaligned 2,5mm	UN	6	292	Zinc	-
	DIV-70088	8x115mm Square Misaligned 2,5mm	UN	6	334	Zinc	-

NOTE: Included screws except where indicated.

The total or partial reproduction of this list is forbidden without the authorization of ALUALPHA S. A.

Other colors see page 1



KITS AND COMPLEMENTS

Other series







	REF.	DESIGNATION	UNITS	PACKING	PACK.GR.	FINISHING	OBSERVATIONS
	S12	Connection Mechanism for Exterior Opening	UN	20	1182	Black Nylon	-
	S6	Connection Kit for Exterior Opening	PAIRS	40	1949	Black Nylon	-
	S8	Connection Kit for Exterior Opening	PAIRS	40	1595	Black Nylon	For A.07 series
	S11	Connection Kit for Exterior Opening	PAIRS	40	1646	Black Nylon	For HP series
	S14P16	Forks Extender w/ Connection Pins	PAIRS	50	2700	Zinc	16mm Pins
	S14P23	Forks Extender w/ Connection Pins	PAIRS	50	2940	Zinc	23mm Pins
	S4	Nylon Cremona Connection Kit w/ Terminal and Locking Meeting	UN	20	1008	Black Nylon	For BP/A1/A6 series
	S1	Nylon Cremona Connection Kit w/ Terminal and Locking Meeting	UN	20	1348	Black Nylon	For 40/20 series

NOTE: Included screws except where indicated.

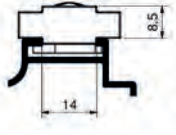
KITS AND COMPLEMENTS



Other series

	REF.	DESIGNATION	UNITS	PACKING	PACK.GR.	FINISHING	OBSERVATIONS
	COMP-33010	Nylon Double Locking Meeting	UN	50	924	-	 For HP series
	OBM-9313	Additional Locking Point for Curtain Wall Series	UN	50	1778	Zinc	-
	OBM-9317	Additional Locking Point for Curtain Wall Series	UN	50	2700	Zinc	-
	9330	Additional Locking Point for Curtain Wall Series	UN	50	-	Zinc	-
	OBM-9312	Corner Transmission w/ Locking Point	UN	30	2915	Zinc	-
	OBM-9315	Corner Transmission	UN	30	2885	Zinc	-
	33011 (2FAT)	Automatic Passive Leaf Stop	UN	50	1324	-	For BP/A1/A6 series

NOTE: Included screws except where indicated.

The total or partial reproduction of this list is forbidden without the authorization of ALUALPHA S. A.

Other colors see page 1



KITS AND COMPLEMENTS

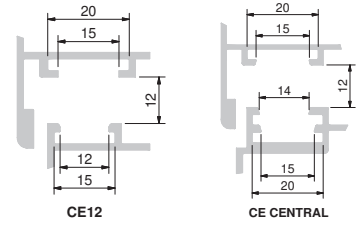

Frame groove 12







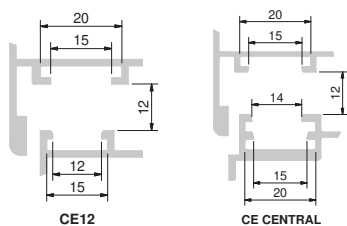



	REF.	DESIGNATION	UNITS	PACKING	PACK.GR.	FINISHING	OBSERVATIONS
	COMP-33039	Zamak Cremona Connection Kit w/ Terminal	CONJ	20	2553	Zinc	-
	KIT-33034	Passive Leaf Kit w/ Zamak Terminal for EG Series (w/o Locking Meeting)	UN	50	2331	Zinc	-
	COMP-33040	Basic Kit for 1st and 2nd Leaf for EG Series - w/ Zamak Terminal (w/o Locking Meeting)	CONJ	20	3485	Zinc	-
	COMP-33001	Nylon Passive Leaf Kit for EG Series - w/ Zamak Locking Meeting	UN	50	2218	Black Nylon	-
	COMP-33003	Nylon Passive Leaf Kit for EG Series - w/ Zamak Low Locking Meeting	UN	50	2145	Black Nylon	-
	COMP-33015	Nylon Passive Leaf Kit for EG Series - Terminal w/ Tuning Tip and Zamak Locking Meeting	UN	50	2682	Black Nylon	-
	COMP-33041	Nylon Passive Leaf Kit for EG Series - Terminal w/ Tuning Tip and Zamak Low Locking Meeting	UN	50	2597	Black Nylon	-
	COMP-33024	Nylon Passive Leaf Kit - Terminal w/ Tuning Tip (w/o Locking Meeting)	UN	50	1788	Black Nylon	-

NOTE: Included screws except where indicated.

KITS AND COMPLEMENTS



Frame groove 12

REF.	DESIGNATION	UNITS	PACKING	PACK.GR.	FINISHING	OBSERVATIONS
 KIT-33038	Nylon Passive Leaf Kit - Terminal w/ Stainless Steel Ø8 Tip for EG Series (w/o Locking Meeting)	UN	50	1934	Black Nylon	-
 COMP-33014	Nylon Kit for 1st and 2nd Leaf for EG Series - Terminal w/ Tuning Tip and Zamak Locking Meeting	UN	20	3057	Black Nylon	-
 COMP-33043	Nylon Kit for 1st and 2nd Leaf for EG Series - Terminal w/ Tuning Tip (w/o Locking Meeting)	UN	20	2360	Black Nylon	-
 COMP-33008	Nylon Cremona Connection Kit	PAIRS	100	1566	Black Nylon	-
 KIT-33033	Zamak Cremona Connection Kit	PAIRS	20	1239	Zinc	-
 COMP-33005	Nylon Terminal	UN	50	435	Black Nylon	-
 COMP-33007	Nylon Terminal w/ Tuning Tip	UN	50	896	Black Nylon	-
 COMP-33006	Terminal w/ Stainless Steel Ø8 Tip	UN	50	1039	Black Nylon	-
 COMP-33017	Terminal w/ Stainless Steel Ø6 Tip	UN	50	941	Black Nylon	-
 COMP-33012	Zamak Terminal	UN	100	2789	Zinc	-

NOTE: Included screws except where indicated.

The total or partial reproduction of this list is forbidden without the authorization of ALUALPHA S. A.

Other colors see page 1



KITS AND COMPLEMENTS

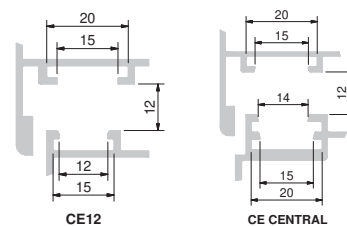

Frame groove 12

	REF.	DESIGNATION	UNITS	PACKING	PACK.GR.	FINISHING	OBSERVATIONS
	KIT-33035	Zamak Door Lock for Passive Leaf	UN	10	1742	Zinc	-
	33055	Passive Leaf Bi-directional Locking Drive	UN	10	-	Stainless Steel	-
	COMP-33023	Double Zamak Locking Meeting	UN	50	1451	Zinc	
	KIT-33004	Low Double Zamak Locking Meeting	UN	100	1663	Zinc	
	COMP-33022	Double Zamak Locking Meeting	UN	100	1872	Zinc	
	OBM-9312	Corner Transmission w/ Locking Point	UN	30	2915	Zinc	-
	OBM-9315	Corner Transmission	UN	30	2885	Zinc	-
	9322	Gearbox Mechanism (7mm Axis)	UN	10	-	Zinc	-
	9323	Gearbox Mechanism (11mm Axis)	UN	10	-	Zinc	-
	9324	Gearbox Mechanism (13,5mm Axis)	UN	10	-	Zinc	-
	PFSUP 18222	Additional Adjustable Locking Point Set	UN	50	2510	Zinc	
	PTSUP 18252	Additional Locking Point	UN	100	2532	Zinc	-

NOTE: Included screws except where indicated.

KITS AND COMPLEMENTS

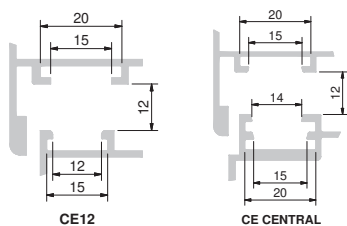

Frame groove 12

	REF.	DESIGNATION	UNITS	PACKING	PACK.GR.	FINISHING	OBSERVATIONS
	ENREG 18253	Adjustable Keeper	UN	100	2241	Zinc	
	OBM-9316	Additional Adjustable Locking Point	UN	100	800	Zinc	-
	OBG-70077	Transmission Cremona Cover	UN	30	1144	Zinc	-
	CAJUSTE 18221	Leaf Support	UN	50	503	Black Nylon	
	MICROVEN	Microventilation Set	UN	20	1099	Zinc	
	33011 (2FAT)	Automatic Passive Leaf Stop	UN	50	1324	-	-
	FECRAMPA	Adjustable Hidden Lock Ramp	UN	50	1316	Zinc	
	COMP-33042	Lock Shield for Cylinder	UN	25	726	Powder Painting	-
	33050	Lock Shield for Cylinder	UN	25	1578	Powder Painting	-
	33069	Lock Shield for Cylinder	UN	25	-	Powder Painting	-
	KIT-33056	Fixation Kit f/ Double Handle (Profile 22 to 33mm)	UN	6	-	Zinc	-
	KIT-33057	Fixation Kit f/ Double Handle (Profile 33 to 45mm)	UN	6	-	Zinc	-
	DIV-70067	8x80mm Square	UN	6	233	Zinc	-
	DIV-70058	8x100mm Square	UN	6	292	Zinc	-
	DIV-70089	8x140mm Square	UN	6	-	Zinc	-
	DIV-70068	8x100mm Square Misaligned 2,5mm	UN	6	292	Zinc	-
	DIV-70088	8x115mm Square Misaligned 2,5mm	UN	6	334	Zinc	-

NOTE: Included screws except where indicated.

The total or partial reproduction of this list is forbidden without the authorization of ALUALPHA S. A.

Other colors see page 1





KITS AND COMPLEMENTS

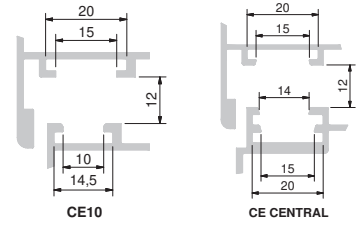

Frame groove 10







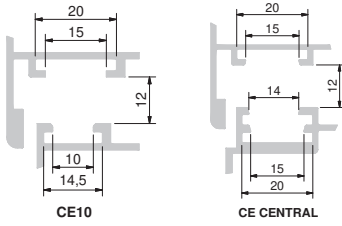

	REF.	DESIGNATION	UNITS	PACKING	PACK.GR.	FINISHING	OBSERVATIONS
	COMP-33039	Zamak Cremona Connection Kit w/ Terminal	CONJ	20	2553	Zinc	-
	KIT-33034	Passive Leaf Kit w/ Zamak Terminal for EG Series (w/o Locking Meeting)	UN	50	2331	Zinc	-
	COMP-33040	Basic Kit for 1st and 2nd Leaf for EG Series - w/ Zamak Terminal (w/o Locking Meeting)	CONJ	20	3485	Zinc	-
	COMP-33001	Nylon Passive Leaf Kit for EG Series - w/ Zamak Locking Meeting	UN	50	2218	Black Nylon	-
	COMP-33003	Nylon Passive Leaf Kit for EG Series - w/ Zamak Low Locking Meeting	UN	50	2145	Black Nylon	-
	COMP-33015	Nylon Passive Leaf Kit for EG Series - Terminal w/ Tuning Tip and Zamak Locking Meeting	UN	50	2682	Black Nylon	-
	COMP-33041	Nylon Passive Leaf Kit for EG Series - Terminal w/ Tuning Tip and Zamak Low Locking Meeting	UN	50	2597	Black Nylon	-
	COMP-33024	Nylon Passive Leaf Kit - Terminal w/ Tuning Tip (w/o Locking Meeting)	UN	50	1788	Black Nylon	-

NOTE: Included screws except where indicated.

KITS AND COMPLEMENTS



Frame groove 10

REF.	DESIGNATION	UNITS	PACKING	PACK.GR.	FINISHING	OBSERVATIONS
 KIT-33038	Nylon Passive Leaf Kit - Terminal w/ Stainless Steel Ø8 Tip for EG Series (w/o Locking Meeting)	UN	50	1934	Black Nylon	-
 COMP-33014	Nylon Kit for 1st and 2nd Leaf for EG Series - Terminal w/ Tuning Tip and Zamak Locking Meeting	UN	20	3057	Black Nylon	-
 COMP-33043	Nylon Kit for 1st and 2nd Leaf for EG Series - Terminal w/ Tuning Tip (w/o Locking Meeting)	UN	20	2360	Black Nylon	-
 COMP-33008	Nylon Cremona Connection Kit	PAIRS	100	1566	Black Nylon	-
 KIT-33033	Zamak Cremona Connection Kit	PAIRS	20	1239	Zinc	-
 COMP-33005	Nylon Terminal	UN	50	435	Black Nylon	-
 COMP-33007	Nylon Terminal w/ Tuning Tip	UN	50	896	Black Nylon	-
 COMP-33006	Terminal w/ Stainless Steel Ø8 Tip	UN	50	1039	Black Nylon	-
 COMP-33017	Terminal w/ Stainless Steel Ø6 Tip	UN	50	941	Black Nylon	-

NOTE: Included screws except where indicated.

The total or partial reproduction of this list is forbidden without the authorization of ALUALPHA S. A.

Other colors see page 1



KITS AND COMPLEMENTS

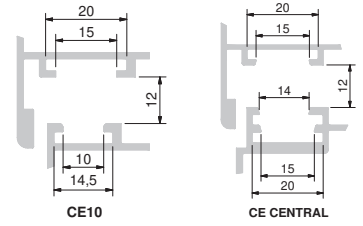

Frame groove 10

	REF.	DESIGNATION	UNITS	PACKING	PACK.GR.	FINISHING	OBSERVATIONS
	COMP-33012	Zamak Terminal	UN	100	2789	Zinc	-
	KIT-33035	Zamak Door Lock for Passive Leaf	UN	10	1742	Zinc	-
	33055	Passive Leaf Bi-directional Locking Drive	UN	10	-	Stainless Steel	-
	COMP-33023	Double Zamak Locking Meeting	UN	50	1451	Zinc	
	KIT-33004	Low Double Zamak Locking Meeting	UN	100	1663	Zinc	
	COMP-33022	Double Zamak Locking Meeting	UN	100	1872	Zinc	
	OBM-9312	Corner Transmission w/ Locking Point	UN	30	2915	Zinc	-
	OBM-9315	Corner Transmission	UN	30	2885	Zinc	-
	9322	Gearbox Mechanism (7mm Axis)	UN	10	-	Zinc	-
	9323	Gearbox Mechanism (11mm Axis)	UN	10	-	Zinc	-
	9324	Gearbox Mechanism (13,5mm Axis)	UN	10	-	Zinc	-

NOTE: Included screws except where indicated.

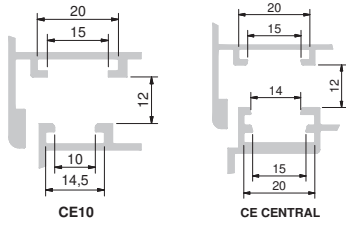

KITS AND COMPLEMENTS



Frame groove 10

	REF.	DESIGNATION	UNITS	PACKING	PACK.GR.	FINISHING	OBSERVATIONS
	PFSUP 18255	Additional Adjustable Locking Point Set	UN	50	2488	Zinc	
	PTSUP 18252	Additional Locking Point	UN	100	2532	Zinc	-
	OBM-9316	Additional Adjustable Locking Point	UN	100	800	Zinc	-
	OBG-70077	Transmission Cremona Cover	UN	30	1144	Zinc	-
	CAJUSTE 18221	Leaf Support	UN	50	503	Black Nylon	
	33011 (2FAT)	Automatic Passive Leaf Stop	UN	50	1324	-	-
	COMP-33042	Lock Shield for Cylinder	UN	25	726	Powder Painting	-
	33050	Lock Shield for Cylinder	UN	25	1578	Powder Painting	-
	33069	Lock Shield for Cylinder	UN	25	-	Powder Painting	-
	KIT-33056	Fixation Kit f/ Double Handle (Profile 22 to 33mm)	UN	6	-	Zinc	-
	KIT-33057	Fixation Kit f/ Double Handle (Profile 33 to 45mm)	UN	6	-	Zinc	-
	DIV-70067	8x80mm Square	UN	6	233	Zinc	-
	DIV-70058	8x100mm Square	UN	6	292	Zinc	-
	DIV-70089	8x140mm Square	UN	6	-	Zinc	-
	DIV-70068	8x100mm Square Misaligned 2,5mm	UN	6	292	Zinc	-
	DIV-70088	8x115mm Square Misaligned 2,5mm	UN	6	334	Zinc	-

NOTE: Included screws except where indicated.





The total or partial reproduction of this list is forbidden without the authorization of ALUALPHA S. A.

Other colors see page 1





LOCKS AND ARMS

	REF.	DESIGNATION	UNITS	PACKING	PACK.GR.	FINISHING	OBSERVATIONS
	509R	Adjustable Finger Catch	UN	25	2474	Powder Painting	For EG Series
	C150	Arms for Bottom-Hung Windows w/ 150mm - EG Series	PAIRS	20	3378	Powder Painting	With opening limiter.
	C220	Arms for Bottom-Hung Windows w/ 220mm - EG Series	PAIRS	30	5538	Powder Painting	With opening limiter.
	C300	Arms for Bottom-Hung Windows w/ 300mm - EG Series	PAIRS	20	4162	Powder Painting	With opening limiter.
	L150	Regulable Limiting Arm w/ 150mm	UN	40	3378	Powder Painting	With pressure regulation.
	L220	Regulable Limiting Arm w/ 220mm	UN	60	5538	Powder Painting	With pressure regulation.
	L300	Regulable Limiting Arm w/ 300mm	UN	40	4162	Powder Painting	With pressure regulation.
	612i	Stainless Steel Arms for Bottom-Hung Windows	PAIRS	20	4150	Stainless Steel	Screws not included. For Conventional Series



PIVOT

	REF.	DESIGNATION	UNITS	PACKING	PACK.GR.	FINISHING	OBSERVATIONS
	601	Pivot Hinge for Horizontal/ Vertical Pivot Windows	PAIRS	1	607	Powder Painting	-

MULTIPOINT LOCKS



MAC

DESIGNATION	UNITS	PACKING	FINISHING	OBSERVATIONS
-------------	-------	---------	-----------	--------------

Multipoint Systems for Cremona - Adjustable Hooks	UN	10	Stainless Steel 304 and Zamak	Integrated anti-lift mechanism and false maneuver. With adjustable nuts.
--	----	----	-------------------------------	---

MAC2
 3380 PACK.GR.
 200

MAC6
 4731 PACK.GR.
 600

MAC10
 5620 PACK.GR.
 1000

MAC16
 7836 PACK.GR.
 1600

MAC18
 9298 PACK.GR.
 1800

MFC

DESIGNATION	UNITS	PACKING	FINISHING	OBSERVATIONS
-------------	-------	---------	-----------	--------------

Multipoint Systems for Cremona - Fixed Hooks	UN	10	Stainless Steel 304 and Zamak	Integrated anti-lift mechanism and false maneuver. With adjustable nuts.
---	----	----	-------------------------------	---

MFC2
 2236 PACK.GR.
 200

MFC6
 3586 PACK.GR.
 600

MFC10
 4475 PACK.GR.
 1000

MFC16
 6133 PACK.GR.
 1600

MFC18
 6800 PACK.GR.
 1800



MULTIPOINT LOCKS

MACK

DESIGNATION	UNITS	PACKING	FINISHING	OBSERVATIONS
-------------	-------	---------	-----------	--------------

Multipoint Systems for Cremona and Cylinder - Adjustable Hooks	UN	10	Stainless Steel 304 and Zamak	Integrated anti-lift mechanism and false maneuver. With adjustable nuts.
--	----	----	-------------------------------	--

MACK6
5780 PACK.GR.

MACK10
6670 PACK.GR.

MACK16
8890 PACK.GR.

MACK18
10350 PACK.GR.

MFCK

DESIGNATION	UNITS	PACKING	FINISHING	OBSERVATIONS
-------------	-------	---------	-----------	--------------

Multipoint Systems for Cremona and Cylinder - Fixed Hooks	UN	10	Stainless Steel 304 and Zamak	Integrated anti-lift mechanism and false maneuver. With adjustable nuts.
---	----	----	-------------------------------	--

MFCK6
4640 PACK.GR.

MFCK10
14,43 €
5530 PACK.GR.

MFCK16
7180 PACK.GR.

MFCK18
7850 PACK.GR.

MULTIPOINT LOCKS



MAE

DESIGNATION	UNITS	PACKING	FINISHING	OBSERVATIONS
-------------	-------	---------	-----------	--------------

Multipoint Systems for Sliding Lock - Adjustable Hooks	UN	10	Stainless Steel 304 and Zamak	-
---	----	----	-------------------------------	---

MAE18
7810 PACK.GR.

MAE16
6368 PACK.GR.

MAE10
4129 PACK.GR.

MAE6
3230 PACK.GR.

MFE

DESIGNATION	UNITS	PACKING	FINISHING	OBSERVATIONS
-------------	-------	---------	-----------	--------------

Multipoint Systems for Sliding Lock - Fixed Hooks	UN	10	Stainless Steel 304 and Zamak	-
--	----	----	-------------------------------	---

MFE18
5570 PACK.GR.

MFE16
4665 PACK.GR.



MFE10
2984 PACK.GR.

MFE6
2110 PACK.GR.







MULTIPOINT LOCKS

Multipoint Accessories

	REF.	DESIGNATION	UNITS	PACKING	PACK.GR.	FINISHING	OBSERVATIONS
	MMM1	Minimalist Handle f/ MFE	UN	10	208	Powder Painting	-
	COMP-33070	Multipoint False Maneuver Deactivator	UN	10	-	Stainless Steel	F/ MFC, MAC, MFCK and MACK

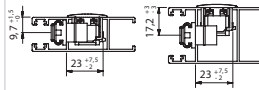

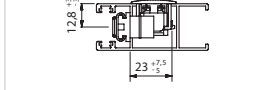
Multipoint / Sliding Locks Connection Hooks

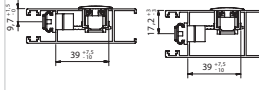
	REF.	DESIGNATION	UNITS	PACKING	PACK.GR.	FINISHING	OBSERVATIONS
	GMA	Hook for Multipoint System	UN	25	208	Zinc	
	GMB	Hook for Multipoint System	UN	25	190	Zinc	
	GMC	Hook for Multipoint System	UN	25	286	Zinc	











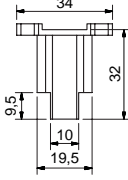

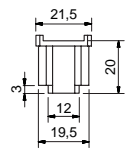

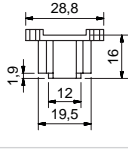

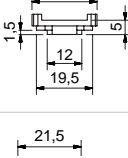

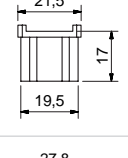
Multipoint Shims

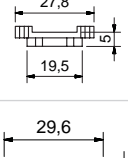
	REF.	DESIGNATION	UNITS	PACKING	PACK.GR.	FINISHING	OBSERVATIONS
	CM0	Set of Blue Wedges for Multipoint	UN	100	760	Black Nylon	
	CM1	Wedge for Thermoline series	UN	100	299	Black Nylon	
	CM2	Wedge for RTC / B055 / LCP-90 / TC4000 series	UN	100	607	Black Nylon	
	CM3	Wedge for Slide 84 series	UN	100	305	Black Nylon	
	CM4	Wedge for L64000 series	UN	100	800	Black Nylon	
	CM5	Wedge for EasySlide (Perim.) / TC4000 series	UN	100	300	Black Nylon	

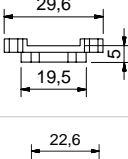
MULTIPOINT LOCKS

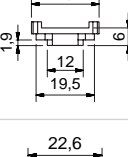

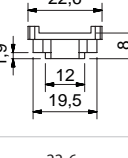

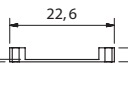







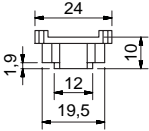

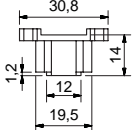

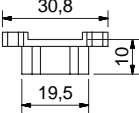

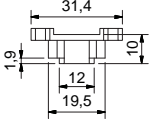
Multipoint Shims

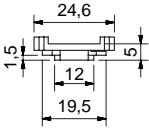
	REF.	DESIGNATION	UNITS	PACKING	PACK.GR.	FINISHING	OBSERVATIONS
	CM6	Wedge for S300 series	UN	100	1000	Black Nylon	
	CM7	Wedge for S350 series	UN	100	700	Black Nylon	
	CM8	Wedge for 7300 series	UN	100	600	Black Nylon	
	CM9	Wedge for LCP-90 RPT / JT / TC600 / TC4200 series	UN	100	350	Black Nylon	
	CM10	Wedge for 4600 RPT series	UN	100	800	Black Nylon	
	CM11	Wedge for N25000 series	UN	100	390	Black Nylon	
	CM12	Wedge for CT / 4200 RPT / Cobalt series	UN	100	401	Black Nylon	
	CM13	Wedge for L60000 series	UN	100	369	Black Nylon	
	CM14	Wedge for CP / LCP-60 / SP / TC600 series	UN	100	423	Black Nylon	
	CM15	Wedge for Gold series	UN	100	100	Black Nylon	

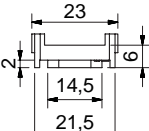

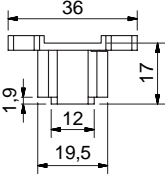
MULTIPOINT LOCKS

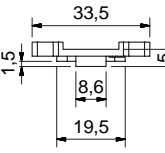
Multipoint Shims

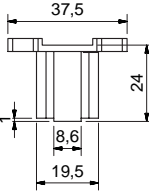
	REF.	DESIGNATION	UNITS	PACKING	PACK.GR.	FINISHING	OBSERVATIONS
	CM16	Wedge for 2000 series	UN	100	400	Black Nylon	
	CM17	Wedge for Brosh series	UN	100	600	Black Nylon	
	CM18	Wedge for RT 90 / ES+ (Perim.) series	UN	100	400	Black Nylon	
	CM19	Wedge for 61Cor Evo / L63000 / PB60 series	UN	100	400	Black Nylon	
	CM20	Wedge for Modena (Perim.) / PB04 series	UN	100	277	Black Nylon	
	CM21	Wedge for 4000 / 4600 / S80 series	UN	100	528	Black Nylon	
	CM22	Wedge for 10000 / S150 series	UN	100	744	Black Nylon	
	CM23	Wedge for PA80 series	UN	100	300	Black Nylon	
	CM24	Wedge for PA110 series	UN	100	900	Black Nylon	

MULTIPOINT LOCKS



Multipoint Shims

	REF.	DESIGNATION	UNITS	PACKING	PACK.GR.	FINISHING	OBSERVATIONS
	CM25	Wedge for S7 series	UN	100	600	Black Nylon	
	CM26	Wedge for VamCor series	UN	100	300	Black Nylon	
	CM29	Wedge for TG-60 series	UN	100	-	Black Nylon	
	CM30	Wedge for J100 / LCB-95 RPT series	UN	100	600	Black Nylon	
	CM32	Wedge for Galisur series	UN	100	442	Black Nylon	
	CM33	Wedge for SlimSlide series	UN	100	100	Black Nylon	
	CM35	Wedge for A300 series	UN	100	760	Black Nylon	
	CM36	Wedge for Konzept100 series	UN	100	1123	Black Nylon	
	CM37	Wedge for Softslide series	UN	100	-	Black Nylon	
	CM38	Wedge for TC6200 series	UN	100	-	Black Nylon	

NEW

NEW



SLIDING ACCESSORIES



	REF.	DESIGNATION	UNITS	PACKING	PACK.GR.	FINISHING	OBSERVATIONS
	33048	Adjustable Locking for Sliding with EG Chamber	UN	25	894	Zinc	-
	33058	Short Adjustable Locking for Sliding with EG Chamber	UN	25	864	Zinc	-
	33066	Long Adjustable Locking for Sliding with EG Chamber	UN	25	924	Zinc	-
	N70	Stainless Steel Counterplate	UN	25	283	Stainless Steel	-
	N77	Stainless Steel Counterplate	UN	25	325	Stainless Steel	-
	9322	Gearbox Mechanism (7mm Axis)	UN	10	-	Zinc	-
	9323	Gearbox Mechanism (11mm Axis)	UN	10	-	Zinc	-
	9324	Gearbox Mechanism (13,5mm Axis)	UN	10	-	Zinc	-
	709D	Right Offset Handle 3 Positions (Square of 7x 32mm)	UN	10	3155	Powder Painting	-
	709E	Left Offset Handle 3 Positions (Square of 7x 32mm)	UN	10	3155	Powder Painting	-
	9326	Flush Handle 3 Positions (Square of 7x 32mm)	UN	10	-	Powder Painting	Also available w/ Square of 7x23mm and 7x60mm
	OBG-70077	Transmission Cremona Cover	UN	30	1144	Zinc	-
	735S	Lower Cremona for Tilt-turn Euro Groove - 12mm Nail (Frontal Fixation)	UN	10	2584	Powder Painting	-
	635S	Cremona for Tilt-turn Euro Groove - 12mm Nail (Frontal Fixation)	UN	10	3060	Powder Painting	-
	635SK	Cremona for Tilt-turn Euro Groove w/ Key - 12mm Nail (Frontal Fixation)	UN	10	3110	Powder Painting	-
	625S	Cremona for Tilt-turn Euro Groove w/ Detachable Cover - 12mm Nail (Frontal Fixation)	UN	10	2685	Powder Painting	-

NEW

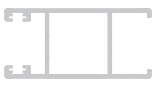

EXO LINE



Conventional Series

	REF.	DESIGNATION	UNITS	PACKING	PACK.GR.	FINISHING	OBSERVATIONS
	2047i	Sliding Lock (Invisible Fixation)	UN	25	-	Powder Painting	
	2047G	Sliding Lock	UN	25	-	Powder Painting	
	2050X	Sliding Lock w/ Hook Extension (Invisible Fixation)	UN	25	-	Powder Painting	
	2050GX	Sliding Lock w/ Hook Extension	UN	25	-	Powder Painting	
	2048i	Sliding Lock - Manual (Invisible Fixation)	UN	25	-	Powder Painting	
	2048G	Sliding Lock - Manual	UN	25	-	Powder Painting	
	2051X	Sliding Lock w/ Hook Extension - Manual (Invisible Fixation)	UN	25	-	Powder Painting	
	2051GX	Sliding Lock w/ Hook Extension - Manual	UN	25	-	Powder Painting	
	2046i	Sliding Lock w/ Security System - Manual (Invisible Fixation)	UN	25	-	Powder Painting	
	2046G	Sliding Lock w/ Security System - Manual	UN	25	-	Powder Painting	
	2045i	Sliding Lock w/ Key (Invisible Fixation)	UN	25	-	Powder Painting	Equal keys
	2045IU	Sliding Lock w/ Key (Invisible Fixation)	UN	25	-	Powder Painting	Diferent keys
	2045G	Sliding Lock w/ Key	UN	25	-	Powder Painting	Equal keys
	2045GU	Sliding Lock w/ Key	UN	25	-	Powder Painting	Diferent keys

NEW

NEW

NEW

NEW

NEW

NEW

NOTE: Nibs and Counterplates not included.

The total or partial reproduction of this list is forbidden without the authorization of ALUALPHA S. A.

Other colors see page 1



EXO LINE

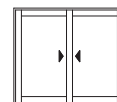

Conventional Series

	REF.	DESIGNATION	UNITS	PACKING	PACK.GR.	FINISHING	OBSERVATIONS
	2053iX	Sliding Lock w/ Key and Hook Extension (Invisible Fixation)	UN	25	-	Powder Painting	Equal keys
	2053iXU	Sliding Lock w/ Key and Hook Extension (Invisible Fixation)	UN	25	-	Powder Painting	Diferent keys
	2053GX	Sliding Lock w/ Key and Hook Extension	UN	25	-	Powder Painting	Equal keys
	2053GXU	Sliding Lock w/ Key and Hook Extension	UN	25	-	Powder Painting	Diferent keys
	2044	Sliding Lock w/ Shell and Key - For Profiles of Width between 27-36mm	PAIRS	12	-	Powder Painting	Diferent keys
	2044i	Sliding Lock w/ Shell and Key - For Profiles of Width between 27-36mm	PAIRS	12	-	Powder Painting	Equal keys
	2044C	Sliding Lock w/ Shell and Key - For Profiles of Width between 27-29mm	PAIRS	12	-	Powder Painting	Diferent keys
	2044E	Sliding Lock w/ Shell and Key - For Profiles of Width between 30-32mm	PAIRS	12	-	Powder Painting	Diferent keys
	2044L	Sliding Lock w/ Shell and Key - For Profiles of Width between 36-48mm	PAIRS	12	-	Powder Painting	Diferent keys
	2052LX	Sliding Lock w/ Shell, Key and Hook Extension - For Profiles of Width between 36-48mm	PAIRS	12	-	Powder Painting	Diferent keys



EXO LINE



Perimetral Series

	REF.	DESIGNATION	UNITS	PACKING	PACK.GR.	FINISHING	OBSERVATIONS
	2057i	Sliding Lock (Invisible Fixation)	UN	25	-	Powder Painting	
	2057G	Sliding Lock	UN	25	-	Powder Painting	
	2058i	Sliding Lock - Manual (Invisible Fixation)	UN	25	-	Powder Painting	
	2058G	Sliding Lock - Manual	UN	25	-	Powder Painting	
	2056i	Sliding Lock w/ Security System - Manual (Invisible Fixation)	UN	25	-	Powder Painting	
	2056G	Sliding Lock w/ Security System - Manual	UN	25	-	Powder Painting	
	2055G	Sliding Lock w/ Key	UN	25	-	Powder Painting	Equal keys
	2055GU	Sliding Lock w/ Key	UN	25	-	Powder Painting	Diferent keys
	2054	Sliding Lock w/ Shell and Key - For Profiles of Width between 27-36mm	PAIRS	12	-	Powder Painting	Diferent keys
	2054C	Sliding Lock w/ Shell and Key - For Profiles of Width between 27-29mm	PAIRS	12	-	Powder Painting	Diferent keys
	2054E	Sliding Lock w/ Shell and Key - For Profiles of Width between 30-32mm	PAIRS	12	-	Powder Painting	Diferent keys
	2054L	Sliding Lock w/ Shell and Key - For Profiles of Width between 36-48mm	PAIRS	12	-	Powder Painting	Diferent keys
	2054XL	Sliding Lock w/ Shell and Key - For Profiles of Width between 40-52mm	PAIRS	12	-	Powder Painting	Diferent keys





NOTE: Nibs and Counterplates not included.

The total or partial reproduction of this list is forbidden without the authorization of ALUALPHA S. A.

Other colors see page 1



Accessories for Sliding Lock

	REF.	DESIGNATION	UNITS	PACKING	PACK.GR.	FINISHING	OBSERVATIONS
	700	Handle f/ Sliding Doors	UN	10	-	Powder Painting	Fixing: aluminium crimping nuts
	701	Handle f/ Sliding Lock	UN	10	-	Powder Painting	-
	2043	Shell f/ Sliding Lock in Zamak	UN	25	-	Powder Painting	-
	2043i	Shell f/ Sliding Doors	UN	25	-	Powder Painting	



Stainless Steel Nibs for Sliding Lock

<p>G1A</p>	<p>G1B</p>	<p>G1C</p>
<p>G1D</p>	<p>G1E</p>	<p>G1F</p>
<p>G1G</p>	<p>G1H</p>	<p>G1i</p>
<p>G1J</p>	<p>G1L</p>	<p>G1M</p>
<p>G1N</p>	<p>G1P</p>	<p>G1Q</p>

REF.	UNITS	PACK.	PACK.GR.
G1A	UN	25	209
G1B	UN	25	213
G1C	UN	25	212
G1D	UN	25	193
G1E	UN	25	196
G1F	UN	25	197
G1G	UN	25	232
G1H	UN	25	221
G1i	UN	25	217
G1J	UN	25	183
G1L	UN	25	187
G1M	UN	25	172
G1N	UN	25	177
G1P	UN	25	174
G1Q	UN	25	265











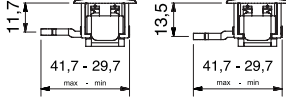
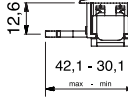





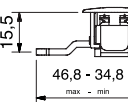

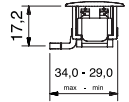
EXO LINE

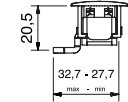
	REF.	DESIGNATION	UNITS	PACKING	PACK.GR.	FINISHING	OBSERVATIONS
	2067i	Sliding Lock w/ 25mm (Invisible Fixation)	UN	100	-	Powder Painting	
	2062	Set of Sliding Lock w/ Handle	UN	10	-	Powder Painting	 Handle with aluminium crimping nuts
	2087i	Long Sliding Lock w/ 25mm (Invisible Fixation)	UN	100	-	Powder Painting	
	2087G	Long Sliding Lock w/ 25mm	UN	100	-	Powder Painting	
	2063i	Shell f/ Sliding Doors	UN	25	-	Powder Painting	

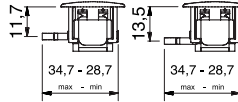

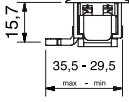
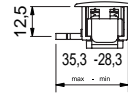
Nickel Steel Nibs for Sliding Lock

			REF.	UNITS	PACK.	PACK.GR.
G5A			G5A	UN	25	218
			G5B	UN	25	225
	G5C		G5C	UN	25	224
	G5D		G5D	UN	25	205
	G5E		G5E	UN	25	205
	G5F		G5F	UN	25	208
	G5G		G5G	UN	25	219
	G5H		G5H	UN	25	226
	G5i		G5i	UN	25	226
	G5J		G5J	UN	25	185
	G5L		G5L	UN	25	191
	G5M		G5M	UN	25	182
	G5N		G5N	UN	25	183
	G5P		G5P	UN	25	175
	G5Q		G5Q	UN	25	265
						



EXO LINE

-
-
-
-
-
-
-
-

REF.	DESIGNATION	UNITS	PACKING	PACK.GR.	FINISHING	OBSERVATIONS
2097i	Sliding Lock (Invisible Fixation)	UN	100	5678	Powder Painting	
	Sliding Lock	UN	100	5678	Powder Painting	
2098P	Sliding Lock Mec. 156/120	UN	100	5480	Powder Painting	
2099P	Sliding Lock Mec. 180/120	UN	100	5390	Powder Painting	
2093i	Shell for Sliding Lock in Aluminium (Invisible Fixation)	UN	100	5678	Powder Painting	
	Shell for Sliding Lock in Aluminium	UN	100	5678	Powder Painting	
2092P	Shell for Sliding Lock in Aluminium Mec. 156/120	UN	100	5480	Powder Painting	
2091P	Shell for Sliding Lock in Aluminium Mec. 180/120	UN	100	5390	Powder Painting	



Nickel Steel Nibs for Sliding Lock

			REF.	UNITS	PACK.	PACK.GR.
<p>G5A</p>   	<p>G5B</p>  	<p>G5C</p>  	G5A	UN	25	218
			G5B	UN	25	225
<p>G5D</p>   	<p>G5E</p>  	<p>G5F</p>  	G5C	UN	25	224
			G5D	UN	25	205
<p>G5E</p>  	<p>G5F</p>  	<p>G5G</p>   	G5E	UN	25	205
			G5F	UN	25	208
<p>G5G</p>   	<p>G5H</p>  	<p>G5i</p>  	G5G	UN	25	219
			G5H	UN	25	226
<p>G5H</p>  	<p>G5i</p>  	<p>G5J</p>  	G5H	UN	25	226
			G5i	UN	25	226
<p>G5J</p>  	<p>G5L</p>  	<p>G5M</p>   	G5J	UN	25	185
			G5L	UN	25	191
<p>G5L</p>  	<p>G5M</p>   	<p>G5N</p>  	G5M	UN	25	182
			G5N	UN	25	183
<p>G5M</p>   	<p>G5N</p>  	<p>G5P</p>  	G5N	UN	25	183
			G5P	UN	25	175
<p>G5N</p>  	<p>G5P</p>  	<p>G5Q</p>   	G5P	UN	25	175
			G5Q	UN	25	265



EXO LINE

Counterplates for Sliding Lock

	REF.	DESIGNATION	UNITS	PACKING	PACK.GR.	FINISHING	OBSERVATIONS
	N28	Counterplates	UN	25	379	Zinc	
	N29	Counterplates	UN	25	338	Zinc	
	N33	Counterplates	UN	25	204	Zinc	
	N34	Counterplates	UN	25	822	Zinc	
	N36	Zamak Nib f/ Perimetral Series	UN	25	314	Zinc	
	N37	Zamak Nib f/ Perimetral Series	UN	25	493	Zinc	
	N38	Zamak Nib f/ Perimetral Series	UN	25	369	Zinc	
	N44	Zamak Nib f/ Perimetral Series	UN	25	507	Zinc	



Conventional Series

	REF.	DESIGNATION	UNITS	PACKING	PACK.GR.	FINISHING	OBSERVATIONS
	247i	Sliding Lock (Invisible Fixation)	UN	25	3218	Powder Painting	
	247G	Sliding Lock	UN	25	2911	Powder Painting	
	250iX	Sliding Lock w/ Hook Extension (Invisible Fixation)	UN	25	3762	Powder Painting	
	250GX	Sliding Lock w/ Hook Extension	UN	25	3375	Powder Painting	
	248i	Sliding Lock - Manual (Invisible Fixation)	UN	25	3134	Powder Painting	
	248G	Sliding Lock - Manual	UN	25	2898	Powder Painting	
	251iX	Sliding Lock w/ Hook Extension - Manual (Invisible Fixation)	UN	25	3762	Powder Painting	
	251GX	Sliding Lock w/ Hook Extension - Manual	UN	25	3375	Powder Painting	
	246i	Sliding Lock w/ Security System - Manual (Invisible Fixation)	UN	25	3219	Powder Painting	
	246G	Sliding Lock w/ Security System - Manual	UN	25	2852	Powder Painting	
	245i	Sliding Lock w/ Key (Invisible Fixation)	UN	25	3834	Powder Painting	Equal keys
	245iU	Sliding Lock w/ Key (Invisible Fixation)	UN	25	3834	Powder Painting	Diferent keys
	245G	Sliding Lock w/ Key	UN	25	3571	Powder Painting	Equal keys
	245GU	Sliding Lock w/ Key	UN	25	3571	Powder Painting	Diferent keys

NOTE: Nibs and Counterplates not included.

The total or partial reproduction of this list is forbidden without the authorization of ALUALPHA S. A.

Other colors see page 1



STAR LINE

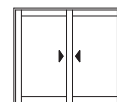

Conventional Series

	REF.	DESIGNATION	UNITS	PACKING	PACK.GR.	FINISHING	OBSERVATIONS
	253IX	Sliding Lock w/ Key and Hook Extension (Invisible Fixation)	UN	25	4350	Powder Painting	Equal keys
	253IXU	Sliding Lock w/ Key and Hook Extension (Invisible Fixation)	UN	25	4350	Powder Painting	Diferent keys
	253GX	Sliding Lock w/ Key and Hook Extension	UN	25	4050	Powder Painting	Equal keys
	253GXU	Sliding Lock w/ Key and Hook Extension	UN	25	4050	Powder Painting	Diferent keys
	244	Sliding Lock w/ Shell and Key - For Profiles of Width between 27-36mm	PAIRS	12	2825	Powder Painting	Diferent keys
	244i	Sliding Lock w/ Shell and Key - For Profiles of Width between 27-36mm	PAIRS	12	2790	Powder Painting	Equal keys
	244N	Sliding Lock w/ Shell and Key - For Profiles of Width between 22-31mm	PAIRS	12	3456	Powder Painting	Diferent keys
	244C	Sliding Lock w/ Shell and Key - For Profiles of Width between 27-29mm	PAIRS	12	2780	Powder Painting	Diferent keys
	244E	Sliding Lock w/ Shell and Key - For Profiles of Width between 30-32mm	PAIRS	12	2786	Powder Painting	Diferent keys
	244L	Sliding Lock w/ Shell and Key - For Profiles of Width between 36-48mm	PAIRS	12	2844	Powder Painting	Diferent keys
	252LX	Sliding Lock w/ Shell, Key and Hook Extension - For Profiles of Width between 36-48mm	PAIRS	12	3096	Powder Painting	Diferent keys
	244W	Wedge for Locks w/ Shell	UN	12	616	Powder Painting	For 244 and 254

NOTE: Nibs and Counterplates not included.

The total or partial reproduction of this list is forbidden without the authorization of ALUALPHA S. A.

Other colors see page 1

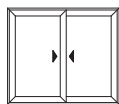

STAR LINE



Perimetral Series

	REF.	DESIGNATION	UNITS	PACKING	PACK.GR.	FINISHING	OBSERVATIONS
	257i	Sliding Lock (Invisible Fixation)	UN	25	2601	Powder Painting	
	257G	Sliding Lock	UN	25	2836	Powder Painting	
	258i	Sliding Lock - Manual (Invisible Fixation)	UN	25	3134	Powder Painting	
	258G	Sliding Lock - Manual	UN	25	2898	Powder Painting	
	256i	Sliding Lock w/ Security System - Manual (Invisible Fixation)	UN	25	2577	Powder Painting	
	256G	Sliding Lock w/ Security System - Manual	UN	25	2822	Powder Painting	
	255G	Sliding Lock w/ Key	UN	25	3478	Powder Painting	Equal keys
	255GU	Sliding Lock w/ Key	UN	25	3478	Powder Painting	Diferent keys
	254	Sliding Lock w/ Shell and Key - For Profiles of Width between 27-36mm	PAIRS	12	2760	Powder Painting	Diferent keys
	254C	Sliding Lock w/ Shell and Key - For Profiles of Width between 27-29mm	PAIRS	12	2748	Powder Painting	Diferent keys
	254E	Sliding Lock w/ Shell and Key - For Profiles of Width between 30-32mm	PAIRS	12	2748	Powder Painting	Diferent keys
	254M	Sliding Lock w/ Shell and Key - For Profiles of Width between 30-41mm	PAIRS	12	2748	Powder Painting	Diferent keys
	254L	Sliding Lock w/ Shell and Key - For Profiles of Width between 36-48mm	PAIRS	12	2813	Powder Painting	Diferent keys
	254XL	Sliding Lock w/ Shell and Key - For Profiles of Width between 40-52mm	PAIRS	12	2856	Powder Painting	Diferent keys
	244W	Wedge for Locks w/ Shell	UN	12	616	Powder Painting	For 244 and 254
	250i	Sliding Lock w/ Perimetral Hook	UN	25	3450	Powder Painting	





NOTE: Nibs and Counterplates not included.

The total or partial reproduction of this list is forbidden without the authorization of ALUALPHA S. A.

Other colors see page 1











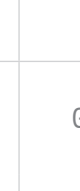



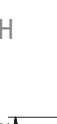

Accessories for Sliding Lock

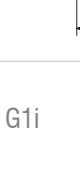
	REF.	DESIGNATION	UNITS	PACKING	PACK.GR.	FINISHING	OBSERVATIONS
	240	Handle for Sliding Doors	UN	10	2351	Powder Painting	Fixing: aluminium crimping nuts
	241	Handle for Sliding Lock	UN	10	1798	Powder Painting	-
	243	Shell for Sliding Lock in Zamak	UN	25	2607	Powder Painting	-
	243i	Shell for Sliding Doors	UN	25	1048	Powder Painting	



Stainless Steel Nibs for Sliding Lock

			REF.	UNITS	PACK.	PACK.GR.
G1A			G1A	UN	25	209
G1B			G1B	UN	25	213
G1C			G1C	UN	25	212
G1D			G1D	UN	25	193
G1E			G1E	UN	25	196
G1F			G1F	UN	25	197
G1G			G1G	UN	25	232
G1H			G1H	UN	25	221
G1i			G1i	UN	25	217
G1J			G1J	UN	25	183
G1L			G1L	UN	25	187
G1M			G1M	UN	25	172
G1N			G1N	UN	25	177
G1P			G1P	UN	25	174
G1Q			G1Q	UN	25	265



STAR LINE

Counterplates for Sliding Lock

	REF.	DESIGNATION	UNITS	PACKING	PACK.GR.	FINISHING	OBSERVATIONS
	N28	Counterplates	UN	25	379	Zinc	
	N29	Counterplates	UN	25	338	Zinc	
	N33	Counterplates	UN	25	204	Zinc	
	N34	Counterplates	UN	25	822	Zinc	
	N36	Zamak Nib for Perimetral Series	UN	25	314	Zinc	
	N37	Zamak Nib for Perimetral Series	UN	25	493	Zinc	

	REF.	DESIGNATION	UNITS	PACKING	PACK.GR.	FINISHING	OBSERVATIONS
	266i	Sliding Lock w/ 30mm (Invisible Fixation)	UN	100	6760	Powder Painting	
	266P	Sliding Lock w/ 30mm	UN	100	6382	Powder Painting	
	267i	Sliding Lock w/ 25mm (Invisible Fixation)	UN	100	6111	Powder Painting	
	267P	Sliding Lock w/ 25mm	UN	100	5752	Powder Painting	
	262	Set of Sliding Lock w/ Handle	UN	10	2372	Powder Painting	 Handle with aluminium crimping nuts
	287i	Long Sliding Lock w/ 25mm (Invisible Fixation)	UN	100	7000	Powder Painting	
	287G	Long Sliding Lock w/ 25mm	UN	100	7065	Powder Painting	
	263i	Shell for Sliding Doors	UN	25	954	Powder Painting	

NOTE: Nibs and Counterplates not included.











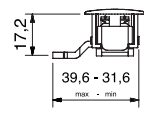

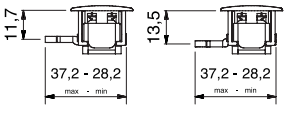

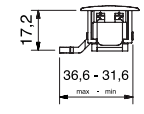
The total or partial reproduction of this list is forbidden without the authorization of ALUALPHA S. A.

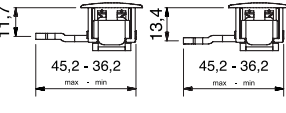
Other colors see page 1

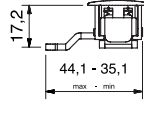



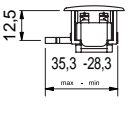

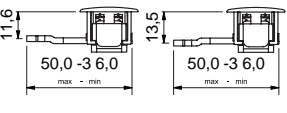

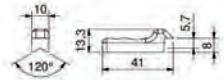
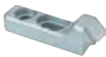
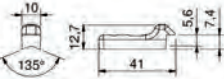

ECO LINE

Nickel Steel Nibs for Sliding Lock

Nickel Steel Nibs for Sliding Lock			REF.	UNITS	PACK.	PACK.GR.
G5A			G5A	UN	25	218
G5B			G5B	UN	25	225
G5C			G5C	UN	25	224
G5D			G5D	UN	25	205
G5E			G5E	UN	25	205
G5F			G5F	UN	25	208
G5G			G5G	UN	25	219
G5H			G5H	UN	25	226
G5i			G5i	UN	25	226
G5J			G5J	UN	25	185
G5L			G5L	UN	25	191
G5M			G5M	UN	25	182
G5N			G5N	UN	25	183
G5P			G5P	UN	25	175
G5Q			G5Q	UN	25	265

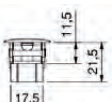

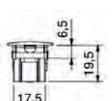
Counterplates for Sliding Lock

	REF.	DESIGNATION	UNITS	PACKING	PACK.GR.	FINISHING	OBSERVATIONS
	N28	Counterplates	UN	25	379	Zinc	
	N29	Counterplates	UN	25	338	Zinc	
	N33	Counterplates	UN	25	204	Zinc	
	N34	Counterplates	UN	25	822	Zinc	
	N38	Zamak Nib for Perimetral Series	UN	25	369	Zinc	
	N44	Zamak Nib for Perimetral Series	UN	25	507	Zinc	



ECO LINE

ECO Line for Profiles up to 25mm













REF.	DESIGNATION	UNITS	PACKING	PACK.GR.	FINISHING	OBSERVATIONS	
	269i	Sliding Lock for Thin Profiles (Invisible Fixation)	UN	100	5936	Powder Painting	
	269P	Sliding Lock for Thin Profiles	UN	100	5625	Powder Painting	

Nickel Steel Nibs for Sliding Lock

REF.	UNITS	PACK.	PACK.GR.	PRICE
G5A	UN	25	218	0,22 €
G5B	UN	25	225	0,22 €
G5C	UN	25	224	0,22 €
G5D	UN	25	205	0,22 €
G5E	UN	25	205	0,22 €
G5F	UN	25	208	0,22 €
G5G	UN	25	219	0,22 €
G5H	UN	25	226	0,22 €
G5i	UN	25	226	0,22 €
G5J	UN	25	185	0,22 €
G5L	UN	25	191	0,22 €
G5M	UN	25	182	0,22 €
G5N	UN	25	183	0,22 €
G5P	UN	25	175	0,22 €
G5Q	UN	25	265	0,22 €

The total or partial reproduction of this list is forbidden without the authorization of ALUALPHA S. A.

Other colors see page 1

	REF.	DESIGNATION	UNITS	PACKING	PACK.GR.	FINISHING	OBSERVATIONS
	297i	Sliding Lock (Invisible Fixation)	UN	100	5678	Powder Painting	
	297P	Sliding Lock	UN	100	5678	Powder Painting	
	298P	Sliding Lock Mec. 156/120	UN	100	5480	Powder Painting	
	299P	Sliding Lock Mec. 180/120	UN	100	5390	Powder Painting	
	293i	Shell for Sliding Lock in Aluminium (Invisible Fixation)	UN	100	5678	Powder Painting	
	293P	Shell for Sliding Lock in Aluminium	UN	100	5678	Powder Painting	
	292P	Shell for Sliding Lock in Aluminium Mec. 156/120	UN	100	5480	Powder Painting	
	291P	Shell for Sliding Lock in Aluminium Mec. 180/120	UN	100	5390	Powder Painting	

NOTE: Included screws except where indicated.
Nibs and Counterplates not included.

The total or partial reproduction of this list is forbidden without the authorization of ALUALPHA S. A.

Other colors see page 1



ALU LINE



Nickel Steel Nibs for Sliding Lock

Nickel Steel Nibs for Sliding Lock			REF.	UNITS	PACK.	PACK.GR.
<p>G5A</p> 	<p>G5B</p> 	<p>G5C</p> 	G5A	UN	25	218
<p>G5D</p> 	<p>G5E</p> 	<p>G5F</p> 	G5B	UN	25	225
<p>G5G</p> 	<p>G5H</p> 	<p>G5i</p> 	G5C	UN	25	224
<p>G5J</p> 	<p>G5L</p> 	<p>G5M</p> 	G5D	UN	25	205
<p>G5N</p> 	<p>G5P</p> 	<p>G5Q</p> 	G5E	UN	25	205
			G5F	UN	25	208
			G5G	UN	25	219
			G5H	UN	25	226
			G5i	UN	25	226
			G5J	UN	25	185
			G5L	UN	25	191
			G5M	UN	25	182
			G5N	UN	25	183
			G5P	UN	25	175
			G5Q	UN	25	265

NOTE: Included screws except where indicated.
Nibs and Counterplates not included.

SLIDING LOCKS



	REF.	DESIGNATION	UNITS	PACKING	PACK.GR.	FINISHING	OBSERVATIONS
	220G	Central Lock for Sliding Serie	UN	12	3248	Powder Painting	42mm stainless steel pin
	203	Central Lock for Sliding Serie	UN	50	5250	Powder Painting	45mm nickel pin

NOTE: Included screws except where indicated.
Nibs and Counterplates not included.

The total or partial reproduction of this list is forbidden without the authorization of ALUALPHA S. A.

Other colors see page 1

















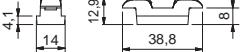





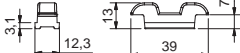

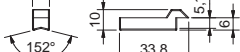



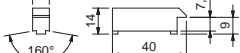

COUNTERPLATES

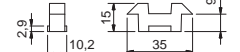
	REF.	FIXAÇÃO	UNITS	PACKING	PACK.GR.	FINISHING	OBSERVATIONS
	N1		UN	25	500	Zinc	
	N3		UN	25	231	Zinc	
	N5		UN	25	243	Zinc	
	N7		UN	25	745	Zinc	
	N9		UN	25	579	Zinc	
	N10		UN	25	513	Zinc	
	N13		UN	25	316	Zinc	
	N14		UN	25	456	Zinc	
	N15		UN	25	533	Zinc	
	N16		UN	25	366	Zinc	
	N17		UN	25	278	Zinc	
	N18		UN	25	241	Zinc	
	N20		UN	25	264	Zinc	
	N24		UN	25	416	Zinc	

COUNTERPLATES

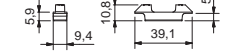

REF.	FIXAÇÃO	UNITS	PACKING	PACK.GR.	FINISHING	OBSERVATIONS
 N25		UN	25	275	Zinc	
 N26		UN	25	224	Stainless Steel	
 N27		UN	25	560	Zinc	
 N28	-	UN	25	379	Zinc	
 N29	-	UN	25	338	Zinc	
 N32		UN	25	484	Zinc	
 N33	-	UN	25	204	Zinc	
 N34	-	UN	25	822	Zinc	
 N39	-	UN	25	406	Zinc	
 N40		UN	25	432	Zinc	
 N43		UN	25	390	Zinc	
 N47	-	UN	25	487	Zinc	
 N49		UN	25	319	Zinc	
 N50	-	UN	25	455	Zinc	



COUNTERPLATES

	REF.	FIXAÇÃO	UNITS	PACKING	PACK.GR.	FINISHING	OBSERVATIONS
	N51	-	UN	25	525	Zinc	
	N52		UN	25	323	Zinc	
	N57		UN	25	305	Powder Painting	
	N58		UN	25	425	Powder Painting	
	N59		UN	25	330	Powder Painting	
	N60		UN	25	215	Powder Painting	
	N61		UN	25	320	Powder Painting	
	N62		UN	25	450	Powder Painting	
	N63		UN	25	658	Zinc	
	N64		UN	25	324	Zinc	
	N65		UN	25	423	Zinc	
	N66		UN	25	602	Zinc	
	N69		UN	25	225	Stainless Steel	

COUNTERPLATES



	REF.	FIXAÇÃO	UNITS	PACKING	PACK.GR.	FINISHING	OBSERVATIONS
	N70		UN	25	283	Stainless Steel	
	N72	-	UN	25	586	Zinc	
	N73		UN	25	634	Zinc	
	N75		UN	25	225	Stainless Steel	
	N76		UN	25	398	Zinc	
	N77		UN	25	325	Stainless Steel	
	N78	-	UN	25	325	Stainless Steel	
	N79		UN	25	-	Stainless Steel	
	N80		UN	25	-	Stainless Steel	
	N85		UN	25	-	Stainless Steel	
	N86	-	UN	25	-	Stainless Steel	
	N87	-	UN	25	-	Stainless Steel	

NEW

NEW

NEW









HANDLES

	REF.	DESIGNATION	UNITS	PACKING	PACK.GR.	FINISHING	OBSERVATIONS
	702	Pull Handle w/ Cam Drive	UN	10	-	Powder Painting	Fixing: aluminium crimping nuts
	700	Pull Handle	UN	10	-	Powder Painting	Fixing: aluminium crimping nuts
	809	Aluminium Door Handle Round	UN	1	471	Powder Painting	-
	240	Handle for Sliding Doors	UN	10	2351	Powder Painting	Fixing: aluminium crimping nuts
	240KD	Right Handle Door for Cylinder	UN	10	2296	Powder Painting	Fixing: aluminium crimping nuts Cylinder not included.
	240KE	Left Handle Door for Cylinder	UN	10	2311	Powder Painting	Fixing: aluminium crimping nuts Cylinder not included.
	200	Door and Blinds Holder	UN	20	2015	Powder Painting	-

NOTE: Included screws except where indicated.

DIVERSE



REF.	DESIGNATION	UNITS	PACKING	PACK.GR.	FINISHING	OBSERVATIONS	
	608D	Bi-direcional Lock for Rods	UN	20	5323	Powder Painting	For 6 mm and 8 mm rods
	608M	Bi-direcional Lock w/ Conection for Polyamide Rod	UN	20	6604	Powder Painting	-
	612i	Stainless Steel Arms for Bottom-Hung Windows	PAIRS	20	4150	Stainless Steel	Screws not included. For Conventional Series
	095	Blinds Holder	UN	100	8497	Powder Painting	For 1 and 2 Leafs Blinds
	096	Long Blinds Holder	UN	80	8718	Powder Painting	For 3 and 4 Leafs Blinds
	092	Window, Door and Blinds Holder	UN	100	1277	Black Nylon	-
	093	Door and Blinds Holder	UN	100	1356	Black Nylon	-

NOTE: Included screws except where indicated.

The total or partial reproduction of this list is forbidden without the authorization of ALUALPHA S. A.

Other colors see page 1



Fabrico e Comercialização de Ferragens, S.A

Estrada do Concelho - Terrugem
2705-572 S. João das Lampas | Portugal
T. +351 219 612 434 | F. +351 219 615 902
Email: info@alualpha.pt | www.alualpha.pt

